



15°



15DC3B



15DC3W



15DC3T

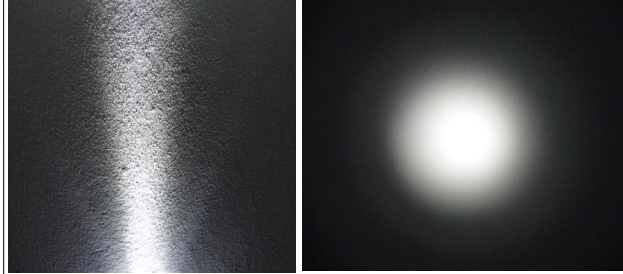

ANGLE	15°
Box Quantiti	125 x 8 = 1000 PCS
Box Size	24 X 24 X 15 CM
Lens Net Kg +/- %3	2,95 Kg
Box Total Kg +/- %3	3,54 Kg
Holder Serial	C 3
Holder Dimension	H: 11,75 D:20
Holder Colour	Black , White ,Transparent.

Led Type

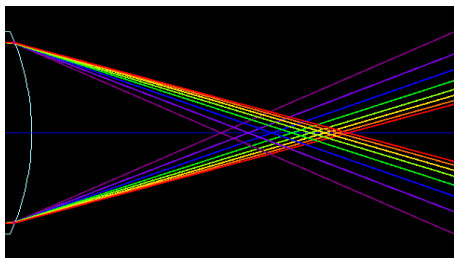
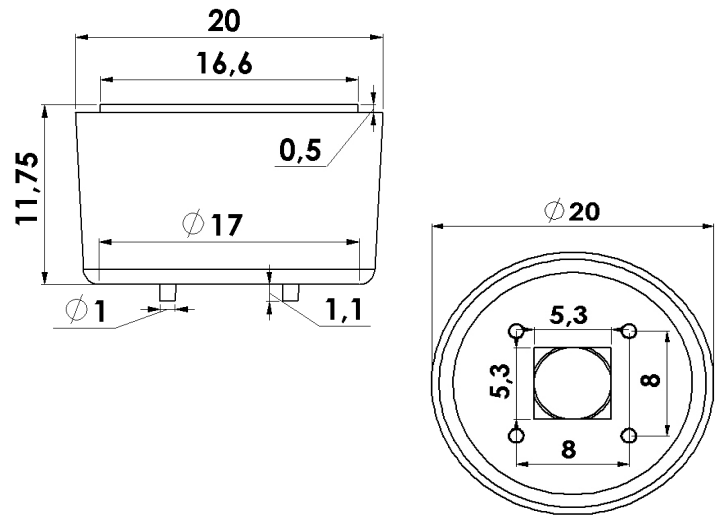
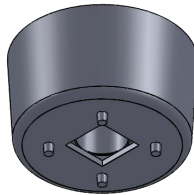

The Focus of Colorful Lights

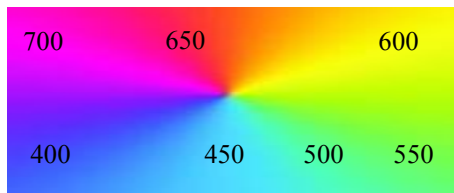

Lighting Nanometer

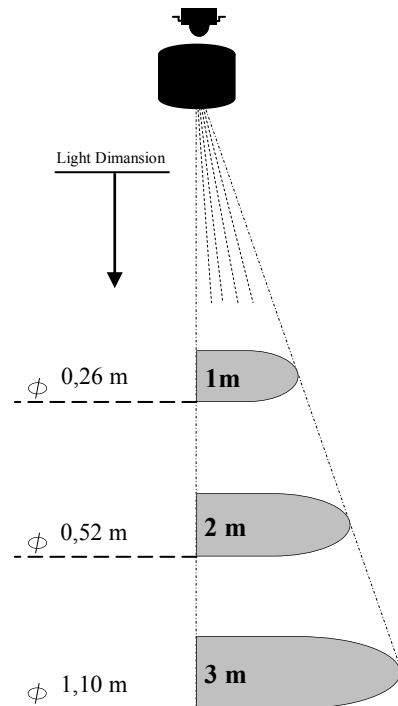
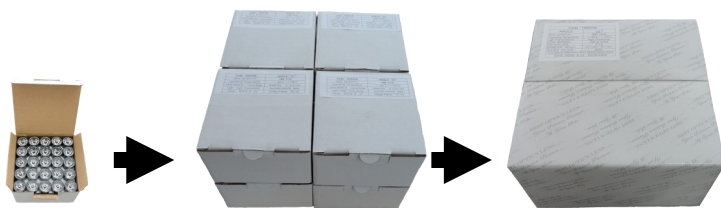

LIGHTING PARAMETERS

LENS USE : Street ,Office,Home,Stage ,Architectural,DownLight , &Decorative Lighting

Lens Material : Optical Grade Best Available Optical Efficiency with high UV & Temperature Resistance -40°C ~ + 100°C Light Transmittance High Productivity with 2mmTh.

Holder info : Operating Temperature -40°C ~ + 120°C PCV2 & R O H S Flame : High Heat Resistance UV Allows use of High Current and Temperature Conditions

WARNING : If you Decide to use Glue only, Please Take Special Care of Correct Positioning