

Silicon PNP Power Transistors

2SA1011

DESCRIPTION

- With TO-220 package
- Complement to type 2SC2344

APPLICATIONS

- High voltage switching ,
- Audio frequency power amplifier;
- 100W output predriver applications

PINNING

PIN	DESCRIPTION
1	Emitter
2	Collector;connected to mounting base
3	Base

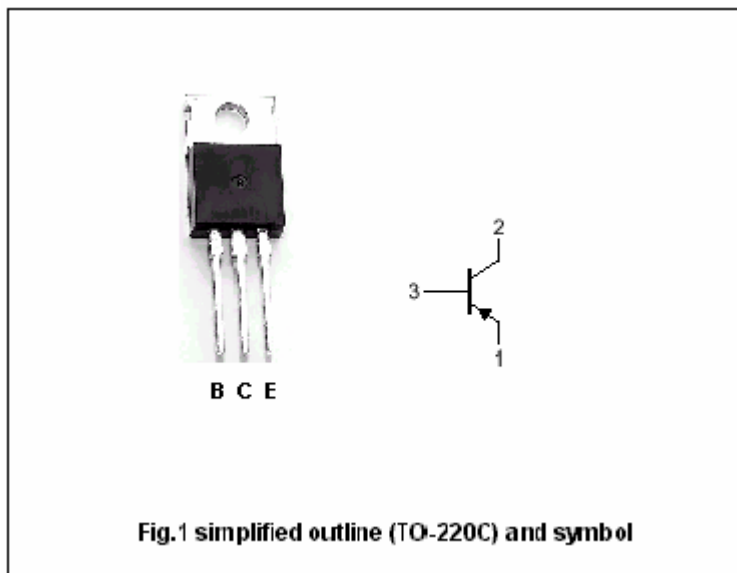

Absolute maximum ratings(Ta=25°C)

SYMBOL	PARAMETER	CONDITIONS	VALUE	UNIT
V _{CBO}	Collector-base voltage	Open emitter	-180	V
V _{CEO}	Collector-emitter voltage	Open base	-160	V
V _{EBO}	Emitter-base voltage	Open collector	-6	V
I _C	Collector current		-1.5	A
I _{CM}	Collector current-Peak		-3.0	A
P _C	Collector power dissipation	T _C =25°C	25	W
T _j	Junction temperature		150	°C
T _{stg}	Storage temperature		-55~150	°C

Silicon PNP Power Transistors

2SA1011

CHARACTERISTICS

T_j=25°C unless otherwise specified

SYMBOL	PARAMETER	CONDITIONS	MIN	TYP.	MAX	UNIT
V _{(BR)CEO}	Collector-emitter breakdown voltage	I _C =-10mA, R _{BE} =∞	-160			V
V _{(BR)CBO}	Collector-base breakdown voltage	I _C =-1mA; I _E =0	-180			V
V _{(BR)EBO}	Emitter-base breakdown voltage	I _E =-1mA; I _C =0	-6			V
V _{CEsat}	Collector-emitter saturation voltage	I _C =-0.5A; I _B =-50mA		-0.5		V
V _{BE}	Base-emitter voltage	I _C =-10mA; V _{CE} =-5V		-1.5		V
I _{CBO}	Collector cut-off current	V _{CB} =-120V; I _E =0			-10	μA
I _{EBO}	Emitter cut-off current	V _{EB} =-4V; I _C =0			-10	μA
h _{FE}	DC current gain	I _C =-0.3A; V _{CE} =-5V	60		200	
f _T	Transition frequency	I _C =-50mA; V _{CE} =-10V		100		MHz
C _{ob}	Output capacitance	I _E =0; f=1MHz; V _{CB} =-10V		30		pF

Switching times resistive load

t _{on}	Turn-on time	I _C =-0.5A; I _{B1} =-I _{B2} =-50mA V _{CC} =20V; R _L =40Ω		0.29		μs
t _s	Storage time			0.48		μs
t _f	Fall time			0.19		μs

◆ h_{FE} Classifications

D	E
60-120	100-200

Silicon PNP Power Transistors

2SA1011

PACKAGE OUTLINE

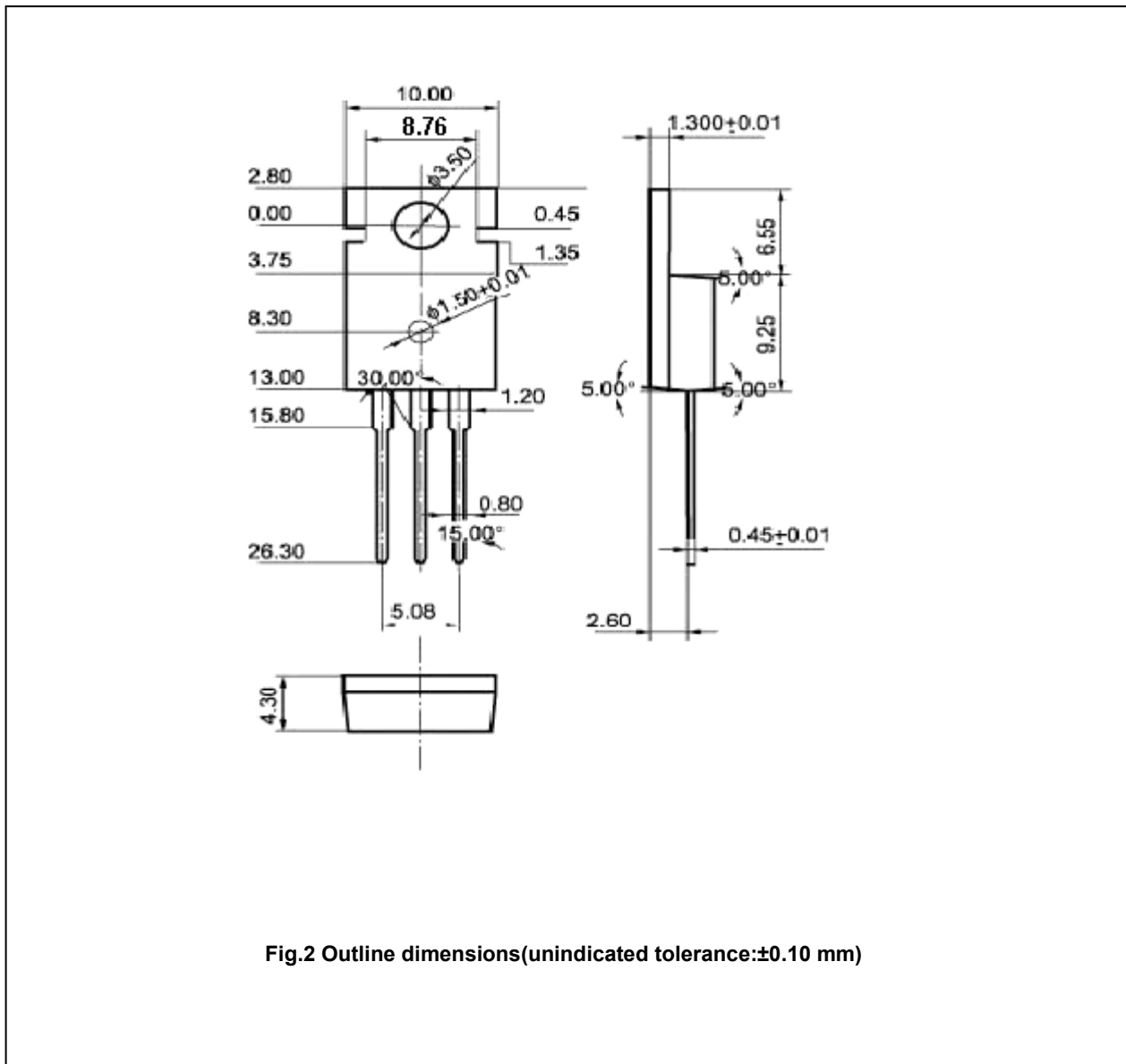

Fig.2 Outline dimensions(unindicated tolerance:±0.10 mm)

Silicon PNP Power Transistors

2SA1011

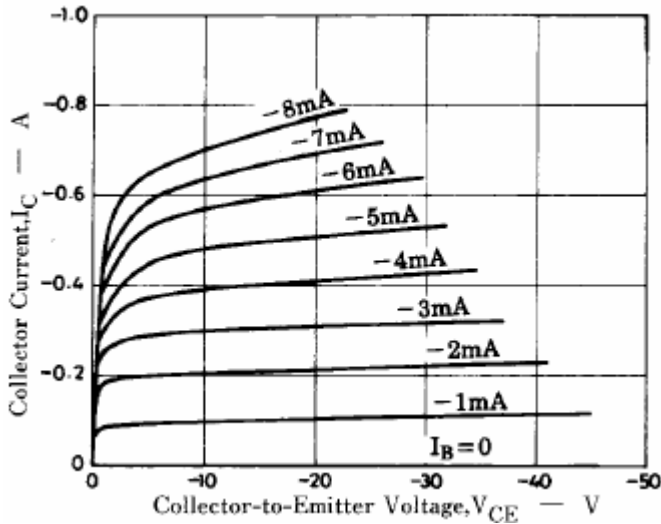

Fig.3 Static Characteristic

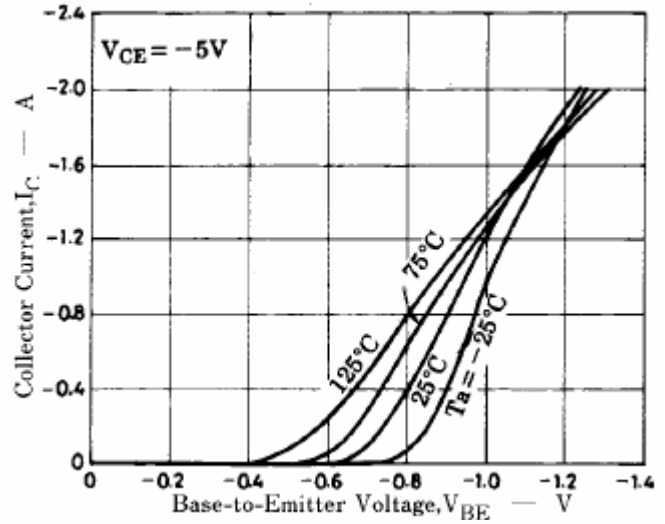

Fig.4 Base-Emitter On Voltage

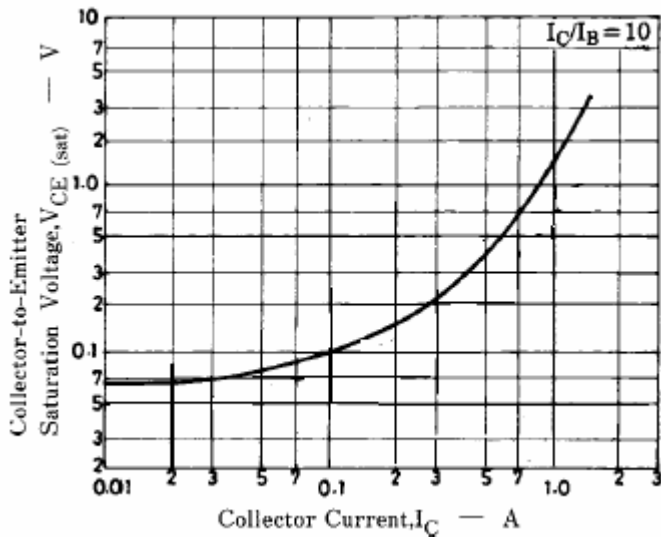

Fig.5 Collector-Emitter Saturation Voltage

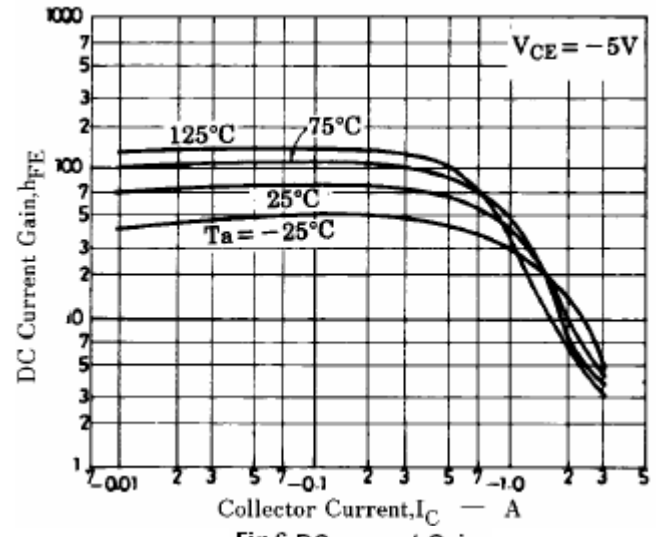

Fig.6 DC current Gain

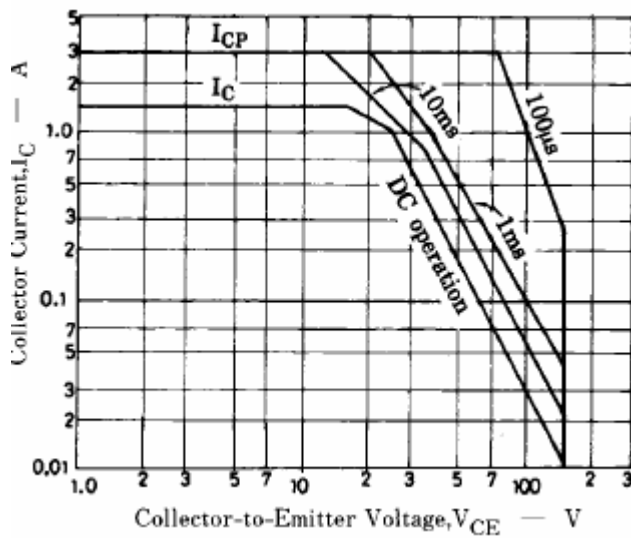

Fig.7 Safe Operating Area