

# 2SC5270, 2SC5270A

Silicon NPN triple diffusion mesa type

For horizontal deflection output

## Features

- High breakdown voltage, and high reliability through the use of a glass passivation layer
- High-speed switching
- Wide area of safe operation (ASO)

## Absolute Maximum Ratings ( $T_C=25^\circ\text{C}$ )

Parameter	Symbol	Rated	Unit
Collector to base voltage	$V_{CBO}$	1500	V
Collector to base voltage		1600	
Collector to base voltage	$V_{CES}$	1500	V
Collector to base voltage		1600	
Collector to emitter voltage	$V_{CEO}$	600	V
Emitter to base voltage	$V_{EBO}$	5	V
Peak collector current	$I_{CP}$	20	A
Collector current	$I_C$	12	A
Base current	$I_B$	8	A
Collector power dissipation	$P_C$	120	W
Collector power dissipation		3	
Junction temperature	$T_j$	150	$^\circ\text{C}$
Storage temperature	$T_{stg}$	-55 to +150	$^\circ\text{C}$

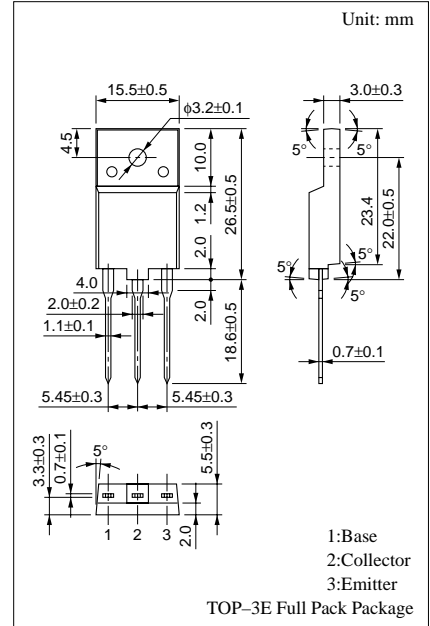

## Electrical Characteristics ( $T_C=25^\circ\text{C}$ )

Parameter	Symbol	Conditions	min	typ	max	Unit
Collector cutoff current	$I_{CBO}$	$V_{CB} = 1000\text{V}, I_E = 0$			50	$\mu\text{A}$
					50	
		$V_{CB} = 1500\text{V}, I_E = 0$			1	mA
			$V_{CB} = 1600\text{V}, I_E = 0$			
Emitter cutoff current	$I_{EBO}$	$V_{EB} = 5\text{V}, I_C = 0$			50	$\mu\text{A}$
Forward current transfer ratio	$h_{FE}$	$V_{CE} = 5\text{V}, I_C = 6\text{A}$	5		12	
Collector to emitter saturation voltage	$V_{CE(sat)}$	$I_C = 6\text{A}, I_B = 1.5\text{A}$			3	V
Base to emitter saturation voltage	$V_{BE(sat)}$	$I_C = 6\text{A}, I_B = 1.5\text{A}$			1.5	V
Transition frequency	$f_T$	$V_{CE} = 10\text{V}, I_C = 0.1\text{A}, f = 0.5\text{MHz}$		3		MHz
Storage time	$t_{stg}$	$I_C = 6\text{A}, I_{B1} = 1.5\text{A}, I_{B2} = -3\text{A}$		1.5	2.5	$\mu\text{s}$
Fall time	$t_f$			0.12	0.2	$\mu\text{s}$

$P_C - T_a$

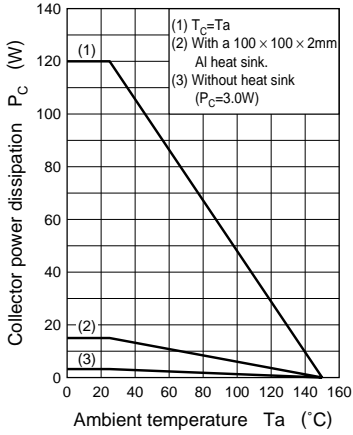

$h_{FE} - I_C$

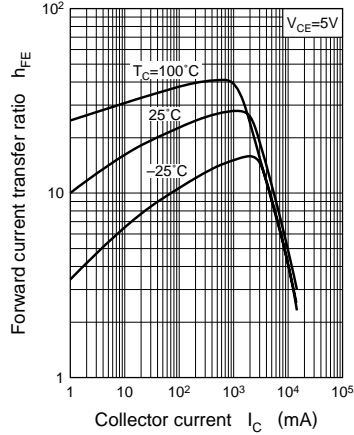

$V_{CE(sat)} - I_C$

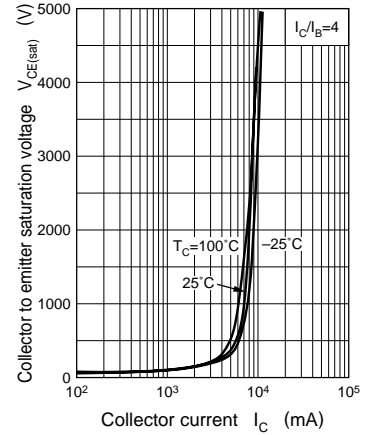

Area of safe operation (ASO)

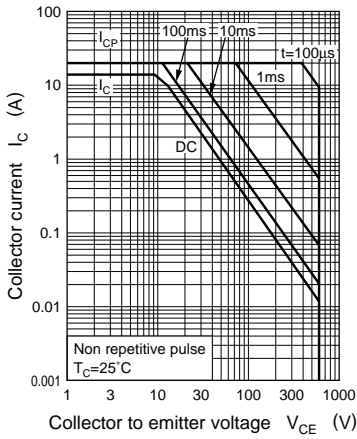

Area of safe operation, horizontal operation ASO

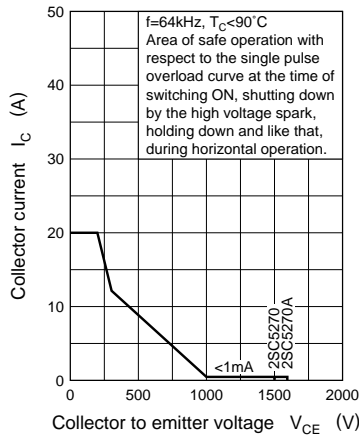

$t_f - I_B$

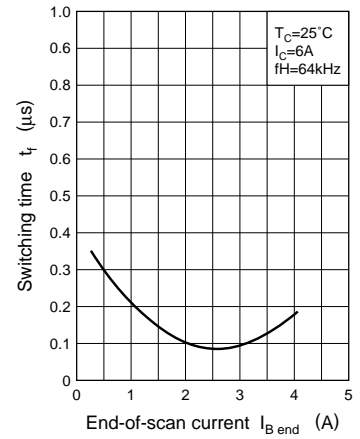

$t_{stg} - I_B$

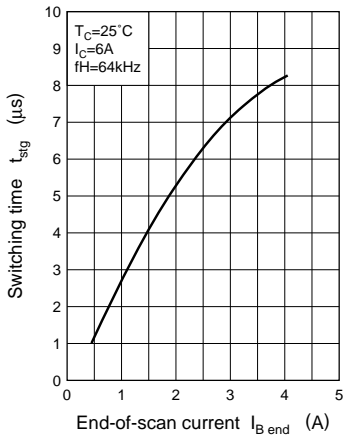

This datasheet has been download from:

[www.datasheetcatalog.com](http://www.datasheetcatalog.com)

Datasheets for electronics components.