

DATA SHEET

BFG591

NPN 7 GHz wideband transistor

Product specification
Supersedes data of November 1992
File under Discrete Semiconductors, SC14

1995 Sep 04

NPN 7 GHz wideband transistor

BFG591

FEATURES

- High power gain
- Low noise figure
- High transition frequency
- Gold metallization ensures excellent reliability.

APPLICATIONS

Intended for applications in the GHz range such as MATV or CATV amplifiers and RF communications subscriber equipment.

DESCRIPTION

NPN silicon planar epitaxial transistor in a plastic, 4-pin SOT223 package.

PINNING

PIN	DESCRIPTION
1	emitter
2	base
3	emitter
4	collector

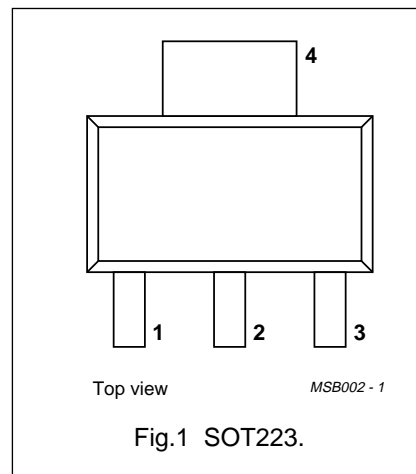

QUICK REFERENCE DATA

SYMBOL	PARAMETER	CONDITIONS	MIN.	TYP.	MAX.	UNIT
V_{CBO}	collector-base voltage	open emitter	–	–	20	V
V_{CEO}	collector-emitter voltage	open base	–	–	15	V
I_C	collector current (DC)		–	–	200	mA
P_{tot}	total power dissipation	up to $T_s = 80\text{ °C}$; note 1	–	–	2	W
h_{FE}	DC current gain	$I_C = 70\text{ mA}$; $V_{CE} = 8\text{ V}$	60	90	250	
C_{re}	feedback capacitance	$I_C = I_c = 0$; $V_{CE} = 12\text{ V}$; $f = 1\text{ MHz}$	–	0.7	–	pF
f_T	transition frequency	$I_C = 70\text{ mA}$; $V_{CE} = 12\text{ V}$; $f = 1\text{ GHz}$	–	7	–	GHz
G_{UM}	maximum unilateral power gain	$I_C = 70\text{ mA}$; $V_{CE} = 12\text{ V}$; $f = 900\text{ MHz}$; $T_{amb} = 25\text{ °C}$	–	13	–	dB
$ S_{21} ^2$	insertion power gain	$I_C = 70\text{ mA}$; $V_{CE} = 12\text{ V}$; $f = 900\text{ MHz}$; $T_{amb} = 25\text{ °C}$	–	12	–	dB

Note

1. T_s is the temperature at the soldering point of the collector pin.

NPN 7 GHz wideband transistor

BFG591

LIMITING VALUES

In accordance with the Absolute Maximum Rating System (IEC 134).

SYMBOL	PARAMETER	CONDITIONS	MIN.	MAX.	UNIT
V_{CBO}	collector-base voltage	open emitter	–	20	V
V_{CEO}	collector-emitter voltage	open base	–	15	V
V_{EBO}	emitter-base voltage	open collector	–	3	V
I_C	collector current (DC)		–	200	mA
P_{tot}	total power dissipation	up to $T_s = 80\text{ °C}$; note 1	–	2	W
T_{stg}	storage temperature		–65	+150	°C
T_j	junction temperature		–	150	°C

THERMAL CHARACTERISTICS

SYMBOL	PARAMETER	CONDITIONS	VALUE	UNIT
$R_{th\ j-s}$	thermal resistance from junction to soldering point	note 1	35	K/W

Note to the Limiting values and Thermal characteristics

- T_s is the temperature at the soldering point of the collector pin.

NPN 7 GHz wideband transistor

BFG591

CHARACTERISTICS

$T_j = 25\text{ °C}$ (unless otherwise specified).

SYMBOL	PARAMETER	CONDITIONS	MIN.	TYP.	MAX.	UNIT
$V_{(BR)CBO}$	collector-base breakdown voltage	$I_C = 0.1\text{ mA}; I_E = 0$	–	–	20	V
$V_{(BR)CES}$	collector-emitter breakdown voltage	$I_C = 10\text{ mA}; I_B = 0$	–	–	15	V
$V_{(BR)EBO}$	emitter-base breakdown voltage	$I_E = 0.1\text{ mA}; I_C = 0$	–	–	3	V
I_{CBO}	collector-base leakage current	$I_E = 0; V_{CB} = 10\text{ V}$	–	–	100	nA
h_{FE}	DC current gain	$I_C = 70\text{ mA}; V_{CE} = 8\text{ V}$	60	90	250	
C_{re}	feedback capacitance	$I_B = I_b = 0; V_{CE} = 12\text{ V};$ $f = 1\text{ MHz}$	–	0.7	–	pF
f_T	transition frequency	$I_C = 70\text{ mA}; V_{CE} = 12\text{ V};$ $f = 1\text{ GHz}$	–	7	–	GHz
G_{UM}	maximum unilateral power gain; note 1	$I_C = 70\text{ mA}; V_{CE} = 12\text{ V};$ $f = 900\text{ MHz}; T_{amb} = 25\text{ °C}$	–	13	–	dB
		$I_C = 70\text{ mA}; V_{CE} = 12\text{ V};$ $f = 2\text{ GHz}; T_{amb} = 25\text{ °C}$	–	7.5	–	dB
$ S_{21} ^2$	insertion power gain	$I_C = 70\text{ mA}; V_{CE} = 12\text{ V};$ $f = 1\text{ GHz}; T_{amb} = 25\text{ °C}$	–	12	–	dB
V_o	output voltage	note 2	–	700	–	mV

Notes

- G_{UM} is the maximum unilateral power gain, assuming s_{12} is zero. $G_{UM} = 10 \log \frac{|S_{21}|^2}{(1 - |S_{11}|^2)(1 - |S_{22}|^2)}$ dB.
- $d_{im} = 60\text{ dB}$ (DIN45004B);
 $V_p = V_o; V_q = V_o - 6\text{ dB}; V_r = V_o - 6\text{ dB};$
 $f_p = 795.25\text{ MHz}; f_q = 803.25\text{ MHz}; f_r = 803.25\text{ MHz};$ measured at $f_{(p+q-r)} = 793.25\text{ MHz}$.

NPN 7 GHz wideband transistor

BFG591

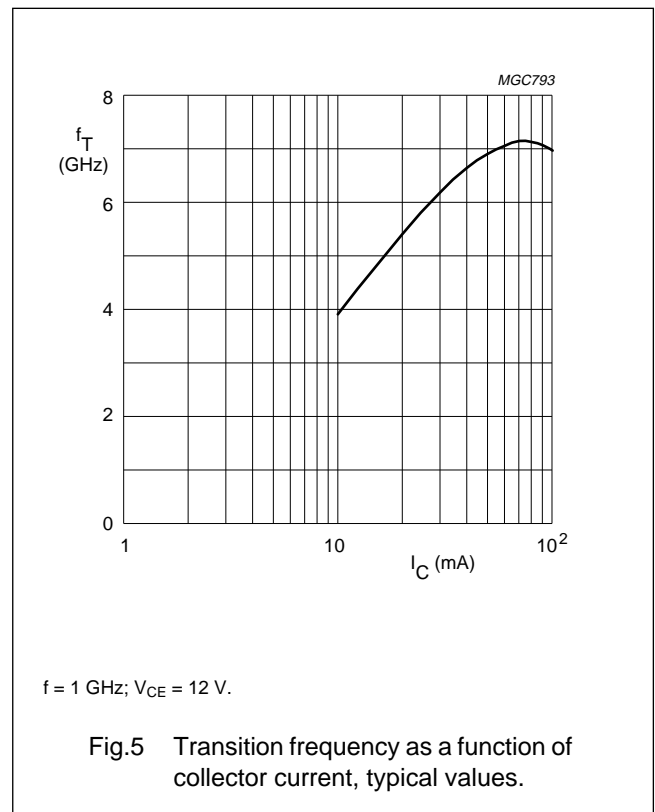
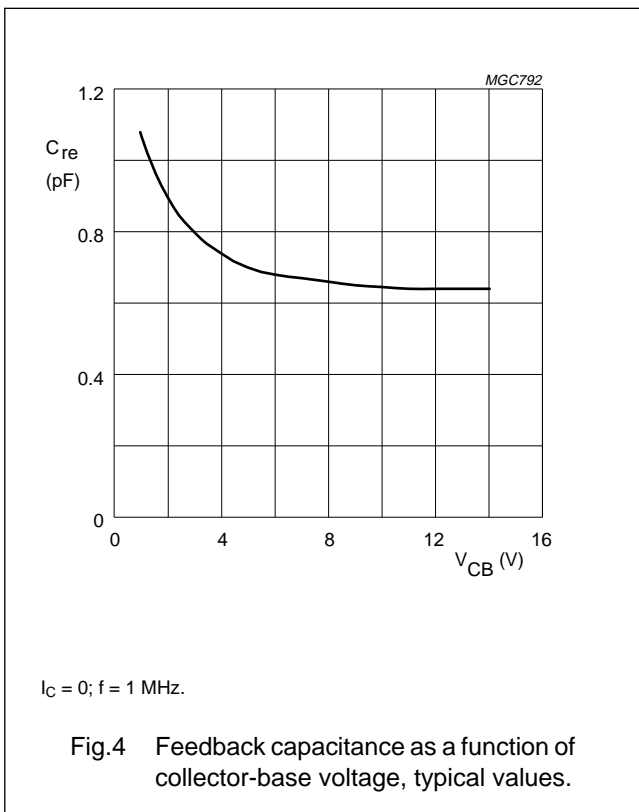
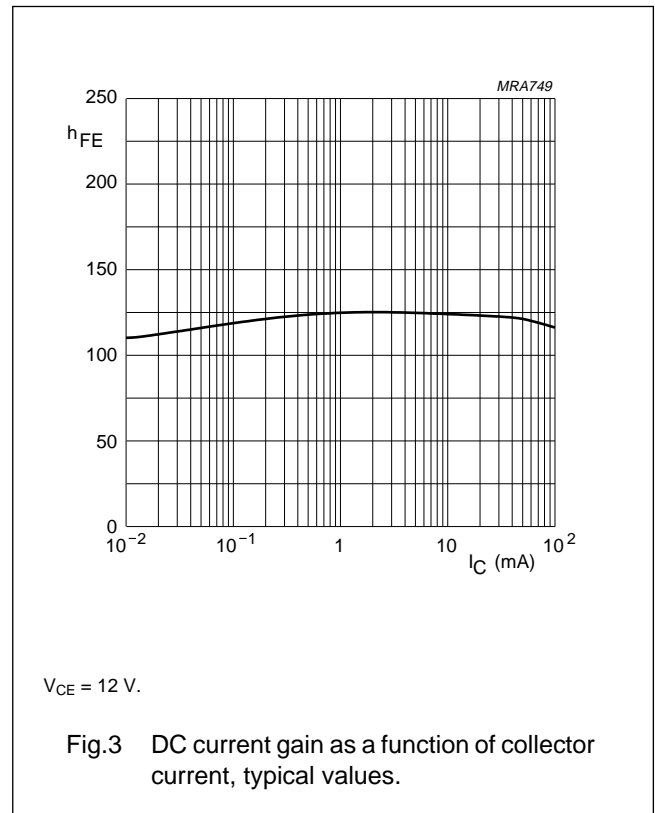
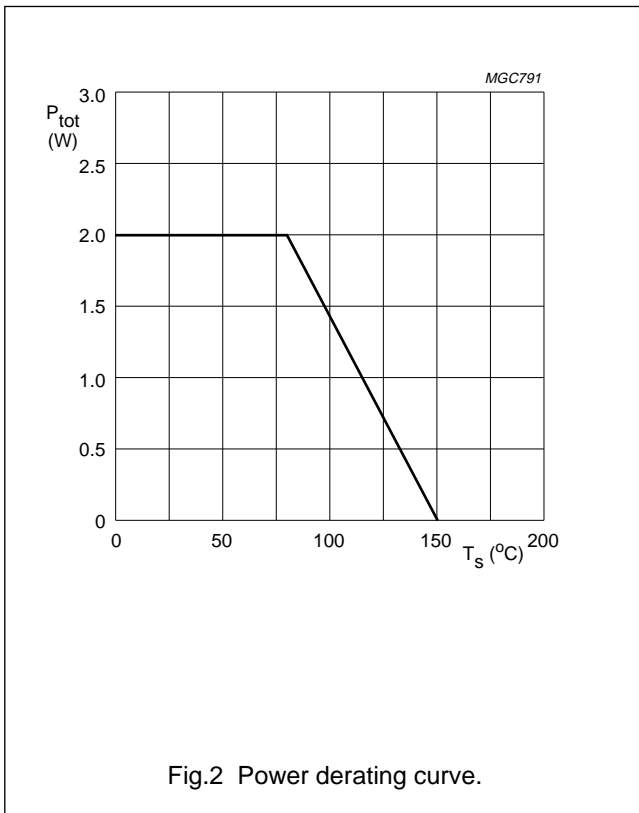

NPN 7 GHz wideband transistor

BFG591

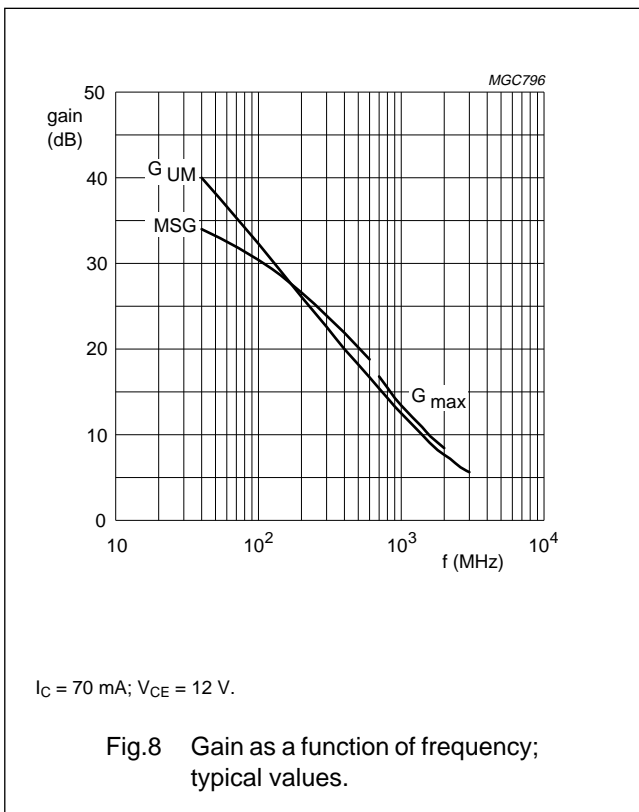
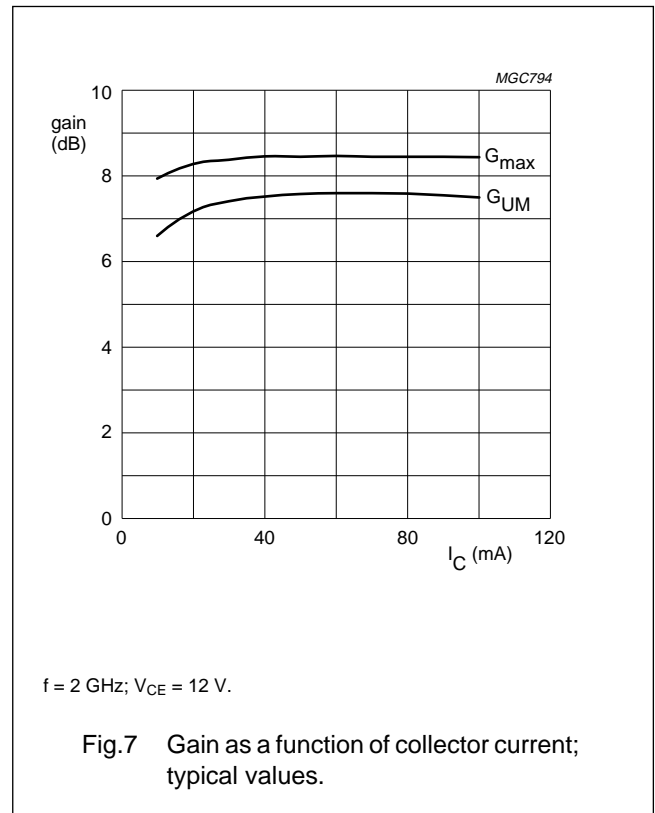
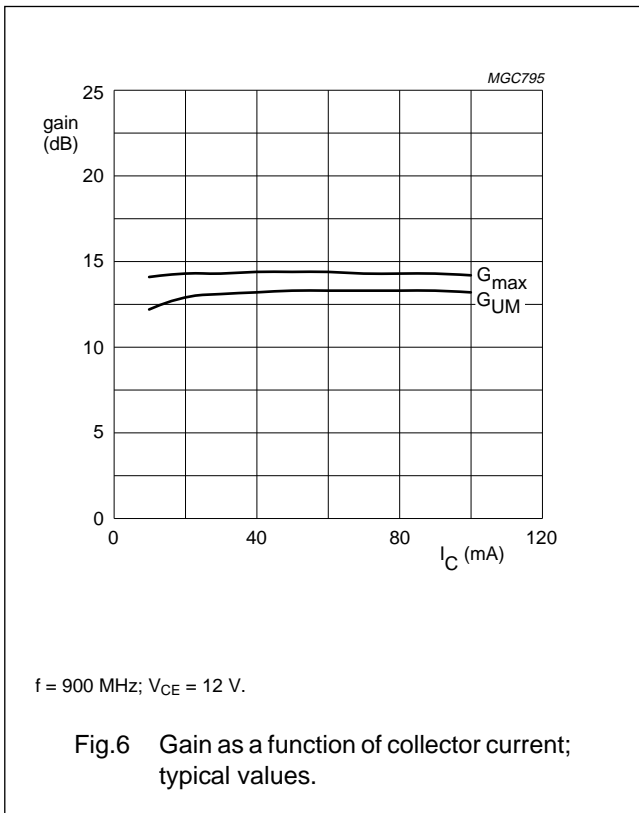

NPN 7 GHz wideband transistor

BFG591

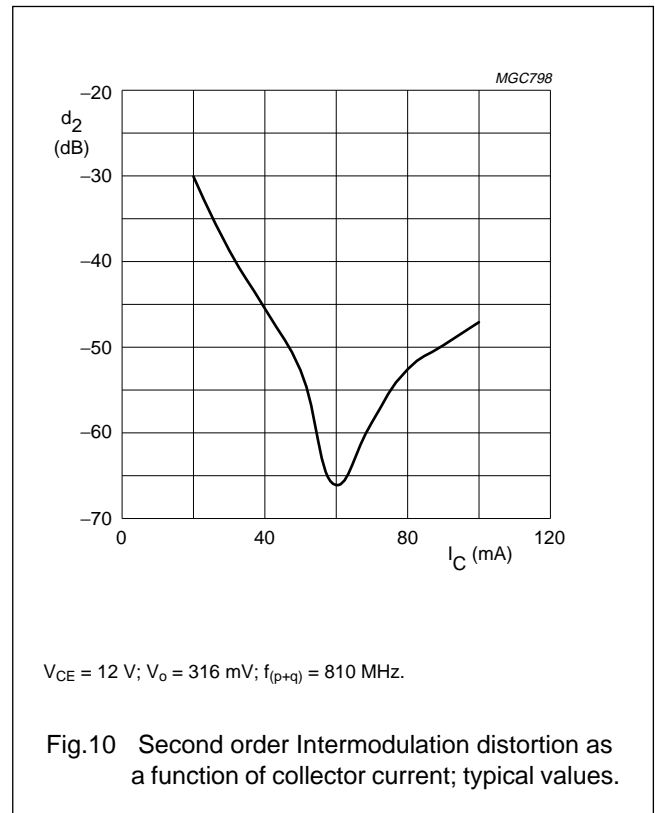
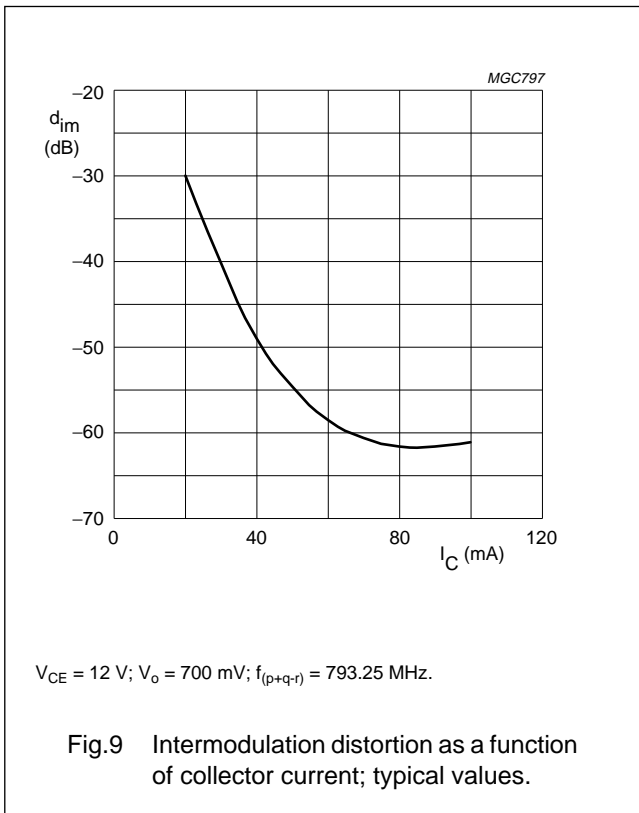

NPN 7 GHz wideband transistor

BFG591

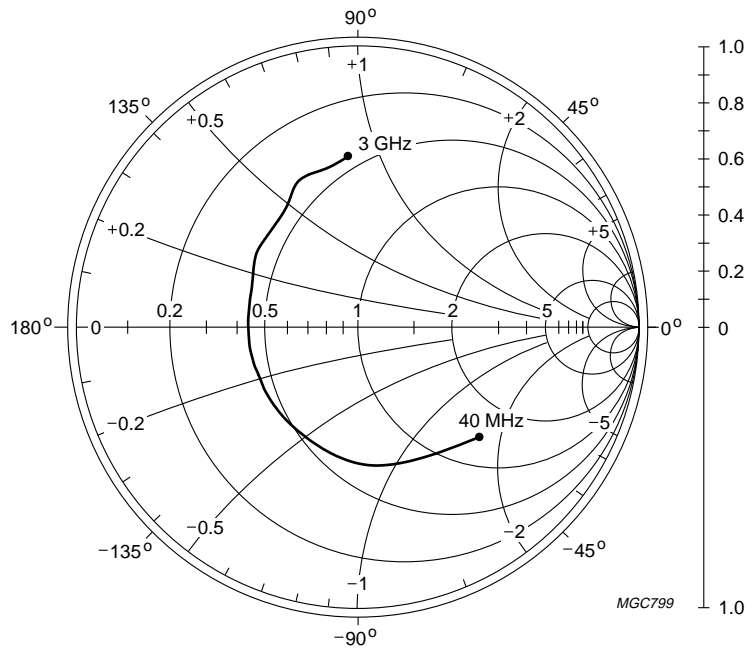

$V_{CE} = 12\text{ V}$; $I_C = 70\text{ mA}$; $Z_0 = 50\ \Omega$.

Fig.11 Common emitter input reflection coefficient (s_{11}); typical values.

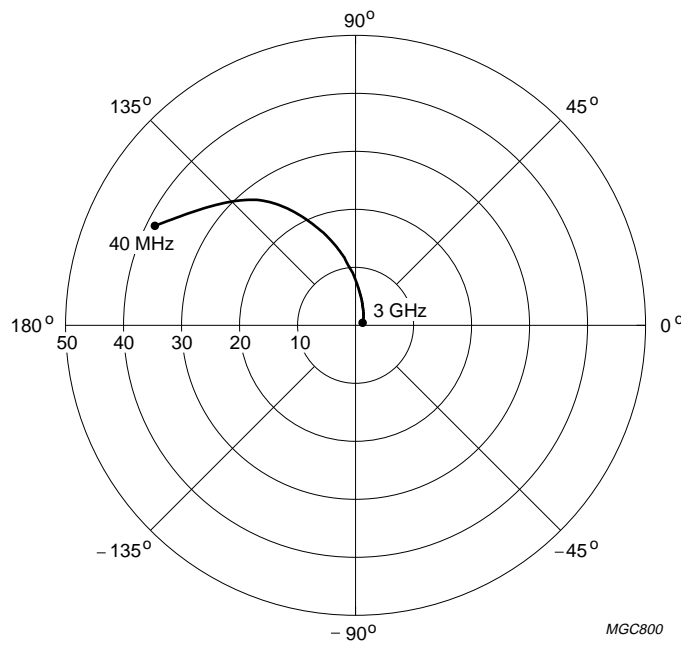

$V_{CE} = 12\text{ V}$; $I_C = 70\text{ mA}$.

Fig.12 Common emitter forward transmission coefficient (s_{21}); typical values.

NPN 7 GHz wideband transistor

BFG591

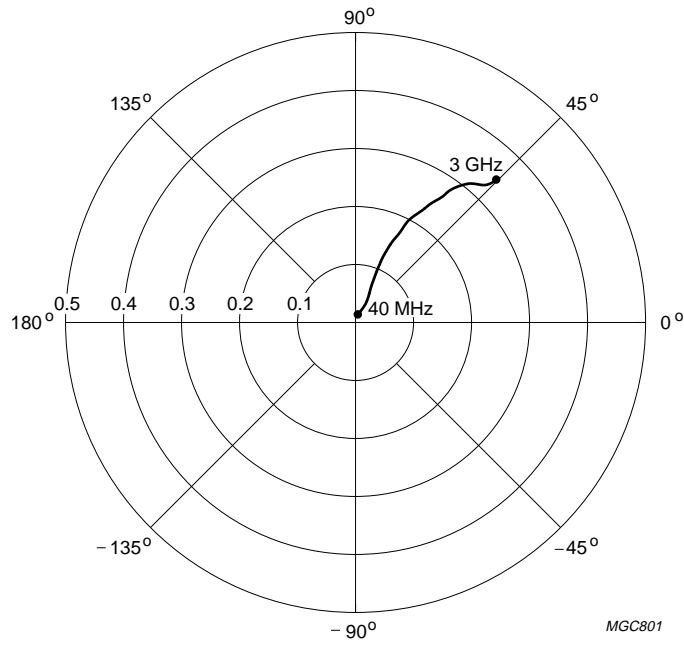

$V_{CE} = 12\text{ V}; I_C = 70\text{ mA}$.

Fig.13 Common emitter reverse transmission coefficient (s_{12}); typical values.

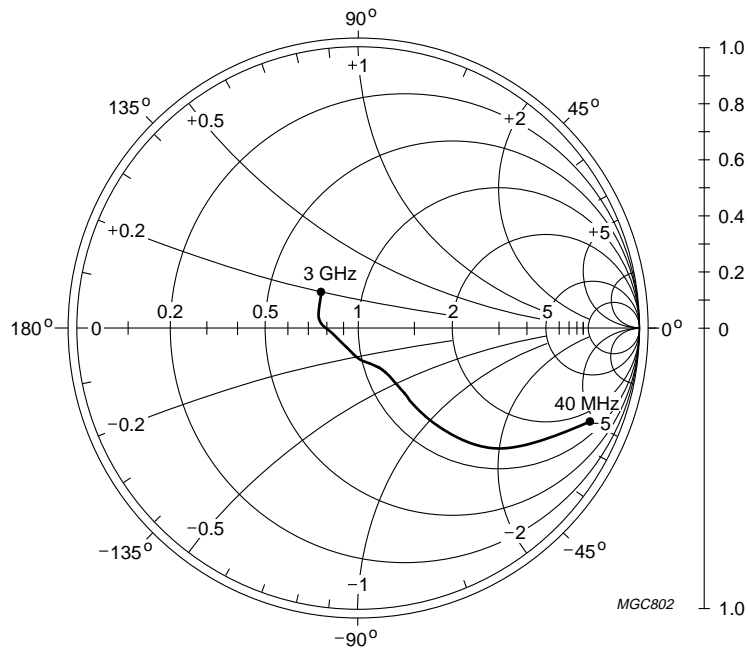

$V_{CE} = 12\text{ V}; I_C = 70\text{ mA}; Z_0 = 50\ \Omega$.

Fig.14 Common emitter output reflection coefficient (s_{22}); typical values.

NPN 7 GHz wideband transistor

BFG591

SPICE parameters for the BFG591 crystal

SEQUENCE No.	PARAMETER	VALUE	UNIT
1	IS	1.341	fA
2	BF	123.5	–
3	NF	.988	m
4	VAF	75.85	V
5	IKF	9.656	A
6	ISE	232.2	fA
7	NE	2.134	–
8	BR	10.22	–
9	NR	1.016	–
10	VAR	1.992	V
11	IKR	294.1	mA
12	ISC	211.0	aA
13	NC	997.2	–
14	RB	5.00	Ω
15	IRB	1.000	μ A
16	RBM	5.00	Ω
17	RE	1.275	Ω
18	RC	920.6	m Ω
19 (1)	XTB	0.000	–
20 (1)	EG	1.110	EV
21 (1)	XTI	3.000	–
22	CJE	3.821	pF
23	VJE	600.0	mV
24	MJE	348.5	m
25	TF	13.60	ps
26	XTF	71.73	–
27	VTF	10.28	V
28	ITF	1.929	A
29	PTF	0.000	deg
30	CJC	1.409	pF
31	VJC	219.4	mV
32	MJC	166.5	m
33	XCJ	2.340	m
34	TR	543.7	ns
35 (1)	CJS	0.000	F
36 (1)	VJS	750.0	mV
37 (1)	MJS	0.000	–
38	FC	733.2	m

Note

1. These parameters have not been extracted, the default values are shown.

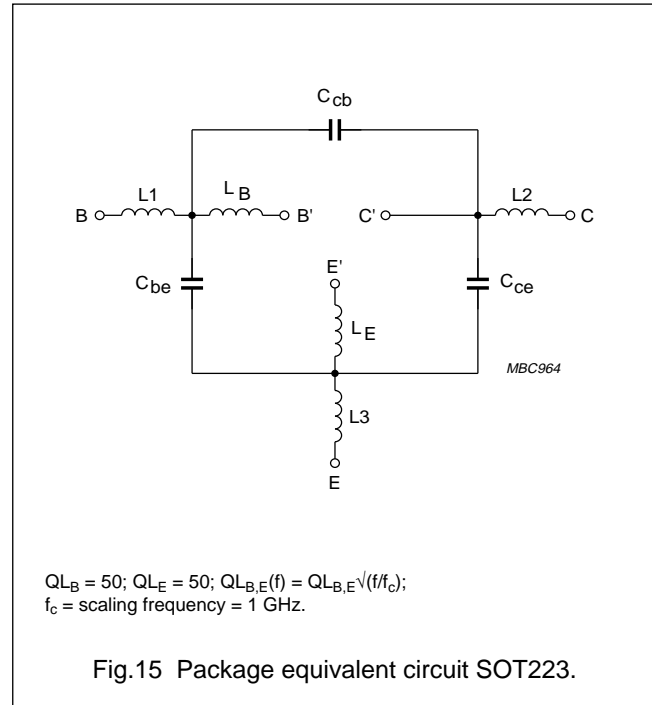

Fig.15 Package equivalent circuit SOT223.

List of components (see Fig.15)

DESIGNATION	VALUE	UNIT
C_{be}	182	fF
C_{cb}	16	fF
C_{ce}	249	fF
L1	0.025	nH
L2	1.19	nH
L3	0.60	nH
L_B	1.50	nH
L_E	0.50	nH

NPN 7 GHz wideband transistor

BFG591

DEFINITIONS

Data Sheet Status	
Objective specification	This data sheet contains target or goal specifications for product development.
Preliminary specification	This data sheet contains preliminary data; supplementary data may be published later.
Product specification	This data sheet contains final product specifications.
Limiting values	
Limiting values given are in accordance with the Absolute Maximum Rating System (IEC 134). Stress above one or more of the limiting values may cause permanent damage to the device. These are stress ratings only and operation of the device at these or at any other conditions above those given in the Characteristics sections of the specification is not implied. Exposure to limiting values for extended periods may affect device reliability.	
Application information	
Where application information is given, it is advisory and does not form part of the specification.	

LIFE SUPPORT APPLICATIONS

These products are not designed for use in life support appliances, devices, or systems where malfunction of these products can reasonably be expected to result in personal injury. Philips customers using or selling these products for use in such applications do so at their own risk and agree to fully indemnify Philips for any damages resulting from such improper use or sale.