

## FEATURES

Conventional LED design : Simple to use

High Flux and Low Cost : More competitive advantages in the LED industry

Special body frame : Excellent transiting heat from LED chip operating under 150mA.

## ADVANTAGES

Operating Current : 150mA .

Custom Design Light Sourcing Module for 0.6W····.

Excellent Heat Dissipation.

## TYPICAL APPLICATIONS

Reading Light / Flashlight / Track Lighting

Under Shelf / Task Lighting

Emergency Lighting / Traffic Signals

Bollards / Security / Garden Lighting

Full Color Sign Boards

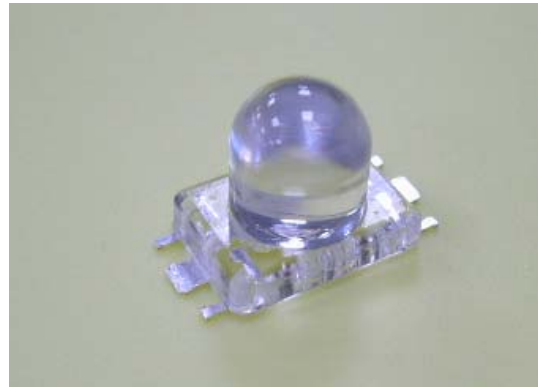

## ABSOLUTE MAXIMUM RATINGS Tj=25°C

Parameter	EP2012-150G1	Units
DC Forward Current	150	mA
Pulsed Forward Current	500	mA
Power Dissipation	520	mW
Dark Current (VR=5V)	100	uA
Operating Temperature Range	-20 to 80	°C
Storage Temperature Range	-35 to 85	°C
Soldering Temperature	245	°C
Thermal Resistance Rθ(°C/W)	85	°C/W
LED Junction Temperature	110	°C

Operating conditions:

1.Amber operating condition under f=0.5 ~ 2 Hz and 1/2 duty factor .

2. 520mw(White) : 6 pins of E-Power LED required soldering on PCB.

( PCB : 24.5 mm \*24.5 mm , 1.6 t / two layers / 2.0 oz . )

3.Convective IR Reflow SolderingConvective IR Reflow Soldering.

## ELECTRICAL CHARACTERISTICS

Tj=25°C IF=150mA

Device Type	Forward Voltage VF (Volts)			Dark Current VR=5V IR=(uA)		Intensity Iv (cd)		Total Flux Φv (lm)	Wavelength λD (nm)	Viewing Angle 2θ1/2 (Degrees)
	Min.	Typ.	Max.	Typ.	Max.	Min.	Typ.	Typ.	Typ.	Typ.
EP2012-150G1	3.0	3.4	4.0	10	100	18	30	3	525	10°

This specification is subject to change without notice.

## OUTLINE DRAWINGS

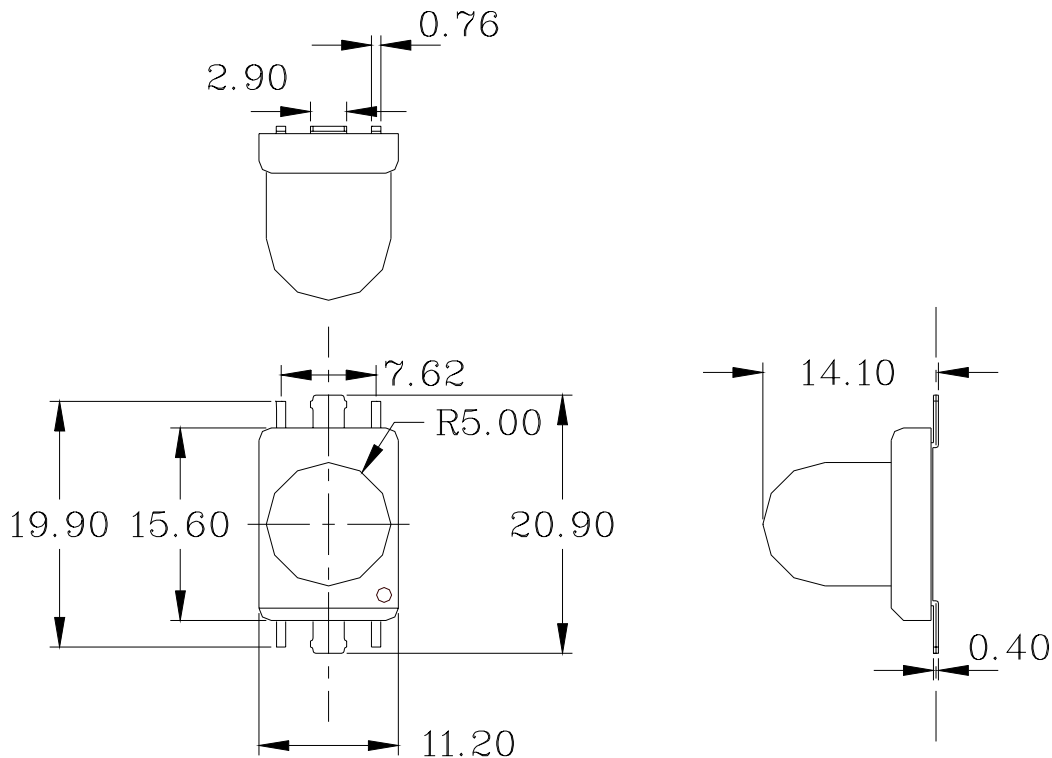

**NOTE**

1. All dimensions are in millimeters.
2. Tolerance is 0.25mm unless otherwise specified.
3. This specification is subject to change without notice.

**CHARACTERISTICS CURVE**

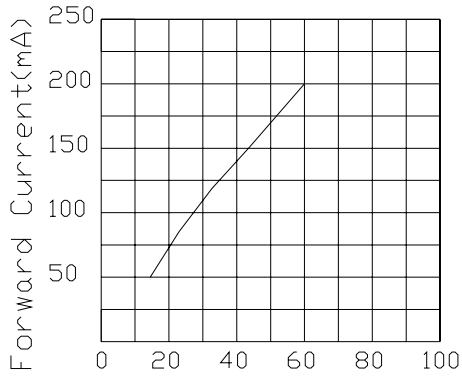

Junction Temperature (°C)  
GREEN

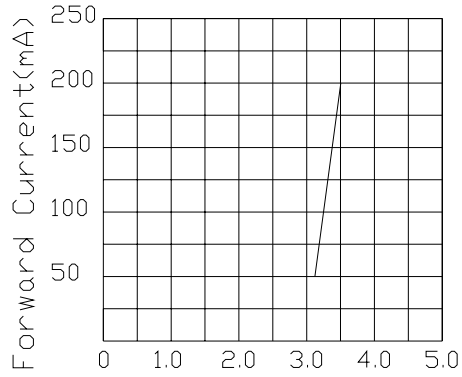

Forward Voltage VF (V)  
GREEN

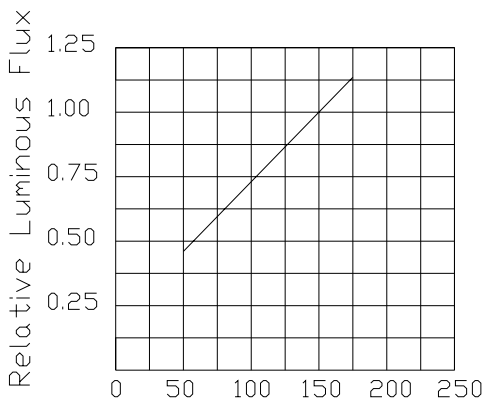

Forward Current (mA)  
GREEN

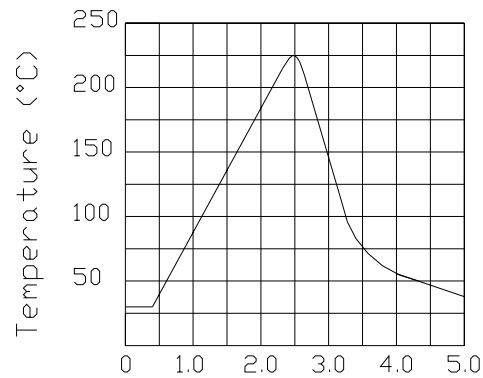

TIME (min)  
Soldering Temperature

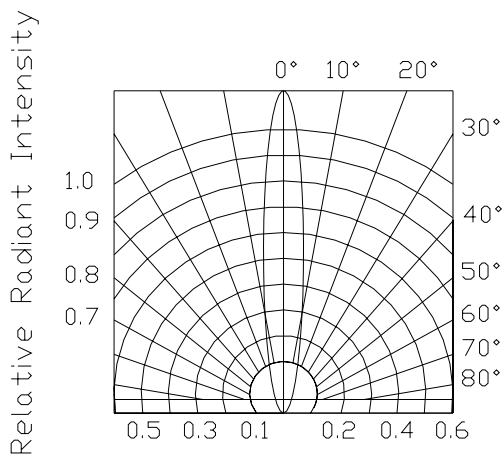

VIEW ANGLE  
EP2012-150XX

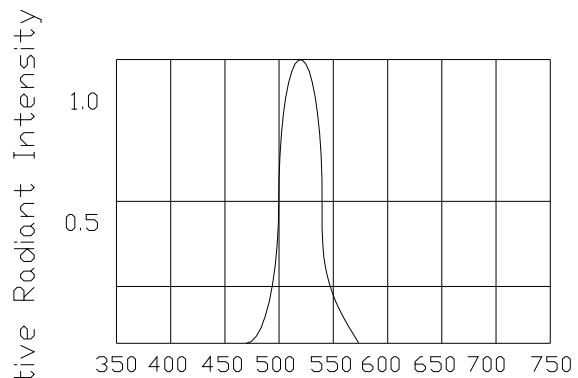

Wavelength (nm)  
Spectral Distribution  
GREEN

## Operation Life

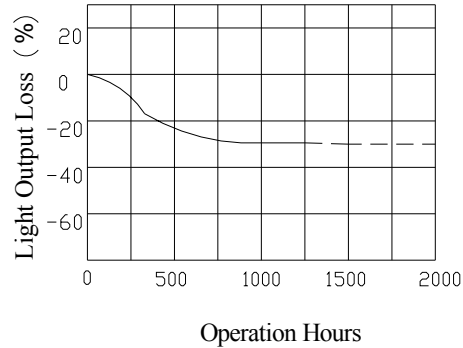

BLUE , CYAN , GREEN , WHITE

## PIN CONNECTION

COLOR	R	G	B	C	A
ANODE	6	6	6	6	6
CATHODE	2 5	3	3	3	2 5

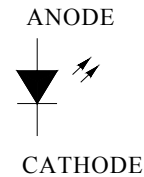
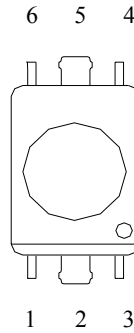

## TEST CIRCUIT

COLOR	Vf(min)	R(100mA)	R(150mA)
G	3.5V	15 Ω	10 Ω

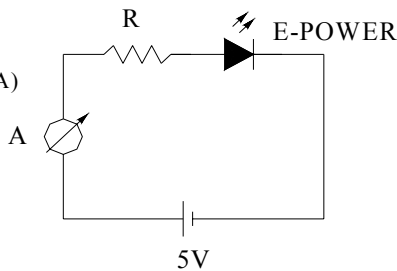

## PART NO. SYSTEM OF E-Power LED

EP 2 01 2-150 G1

1---2-3-4-5-----6-----7

1.E -Power LED

2.YEAR 2002

3.PACKAGE TYPE:01=10mm LENS;03=5mm LENS;04=11 mm LENS

4.VIEWING ANGLE:2\*5=10°

5.CURRENT:150mA

6. λD: G1=525nm (GREEN )