

Radial Leaded PPTC Resettable Fuse: FRX 075-60F

1. Summary

- (a) **RoHS Compliant (Lead Free) Product**
- (b) **Applications: Wide variety of electronic equipment**
- (c) **Product Features: Low hold current, Solid state, Radial leaded product ideal for up to 60V**
- (d) **Operation Current: 750mA**
- (e) **Maximum Voltage: 60V**
- (f) **Temperature Range : -40°C to 85°C**

2. Agency Recognition

UL: File No. E211981
 C-UL: File No. E211981
 TÜV : File No. R50004084

3. Electrical Characteristics (23°C)

Part Number	Hold Current	Trip Current	Max.Time to Trip	Maximum Current	Rated Voltage	Typical Power	Resistance Tolerance	
							R _{MIN}	R _{1MAX}
	I _H , A	I _T , A	at 5xI _H	I _{MAX} , A	V _{MAX} , Vdc	Pd, W	ohms	ohms
FRX075-60F	0.75	1.50	6.3	40	60	0.92	0.25	0.60

I_H=Hold current-maximum current at which the device will not trip at 23°C still air.
 I_T=Trip current-minimum current at which the device will always trip at 23°C still air.
 V_{MAX}=Maximum voltage device can withstand without damage at its rated current.
 I_{MAX}= Maximum fault current device can withstand without damage at rated voltage (V_{MAX}).
 Pd=Typical power dissipated from device when in tripped state in 23°C still air environment.
 R_{MIN}=Minimum device resistance at 23°C.
 R_{1MAX}=Maximum device resistance at 23°C, 1 hour after tripping .

Physical specifications:

Lead material: Tin plated copper, 24 AWG.

Soldering characteristics: MIL-STD-202, Method 208E.

Insulating coating:Flame retardant epoxy, meets UL-94V-0 requirement.

4. Production Dimensions (millimeter)

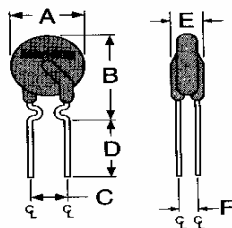

FRX 075-60 F
 Lead Size: 24AWG
 Φ 0.51 mm Diameter

Part Number	A	B	C	D	E	F
	Maximum	Maximum	Typical	Minimum	Maximum	Typical
FRX075-60F	10.4	15.2	5.1	7.6	3.1	1.1

NOTE : Specification subject to change without notice.

5. Thermal Derating Curve

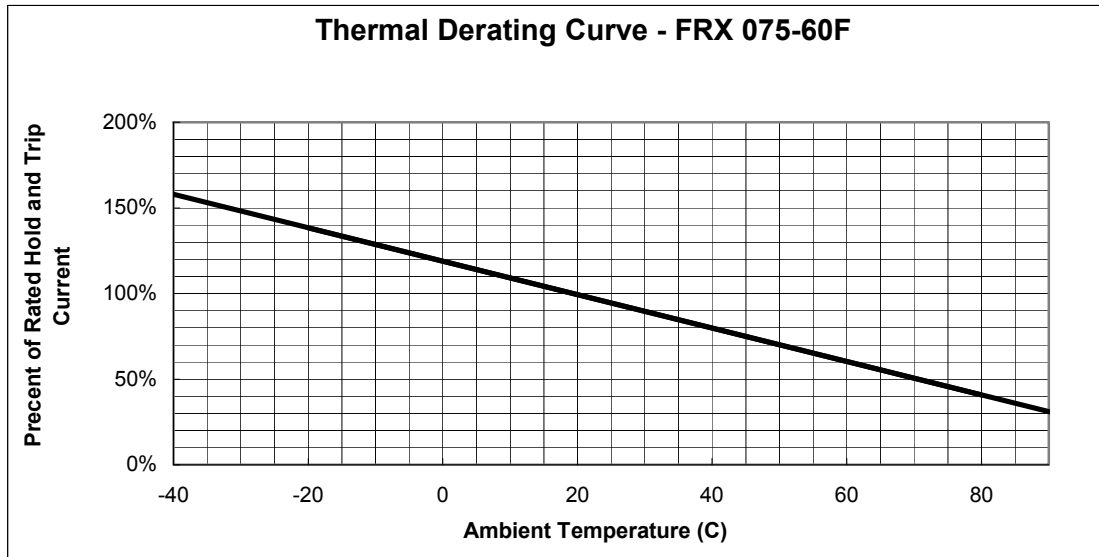

6. Typical Time-To-Trip at 23°C

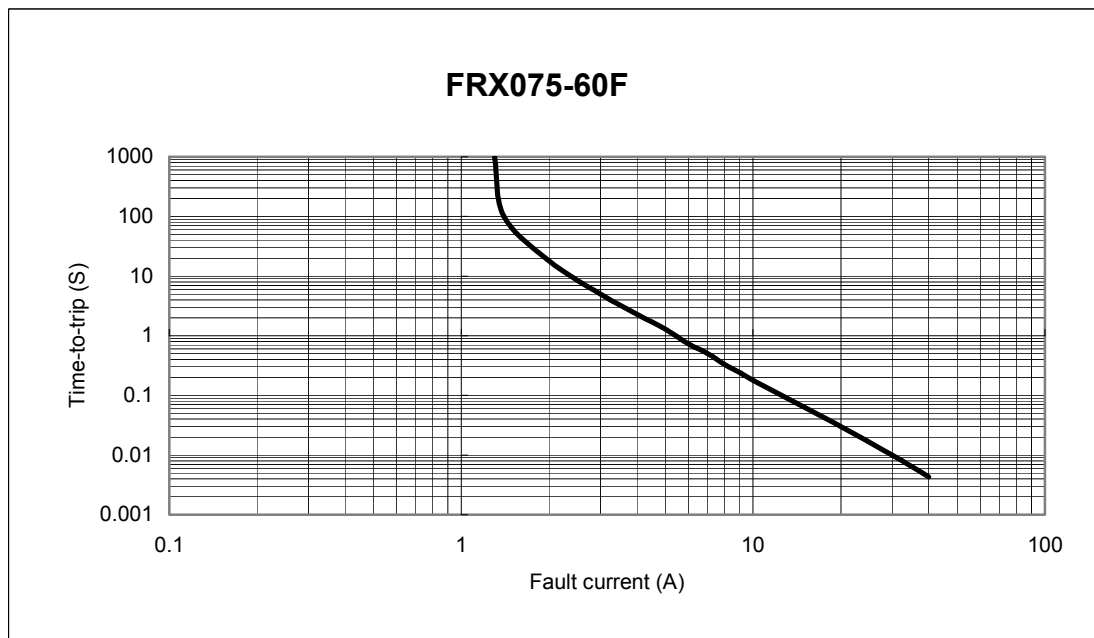

7. Material Specification

Lead material : Tin plated copper, 24 AWG.

Soldering characteristics: MIL-STD-202, Method 208E.

Insulating coating: Flame retardant epoxy, meets UL-94V-0 requirement

8. Part Numbering and Marking System

Part Numbering System

F R X □ □ □ - □ □ F

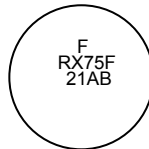
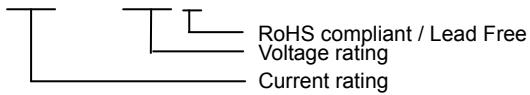

Example

Part Marking System

F

RX □ □ F

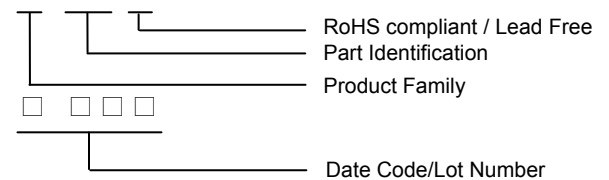

Warning: -Operation beyond the specified maximum ratings or improper use may result in damage and possible electrical arcing and/or flame.



-PPTC device are intended for occasional overcurrent protection. Application for repeated overcurrent condition and/or prolonged trip are not anticipated.

- Avoid contact of PPTC device with chemical solvent. Prolonged contact will damage the device performance.

DIP Type Recommendations of Wave Solder Profile

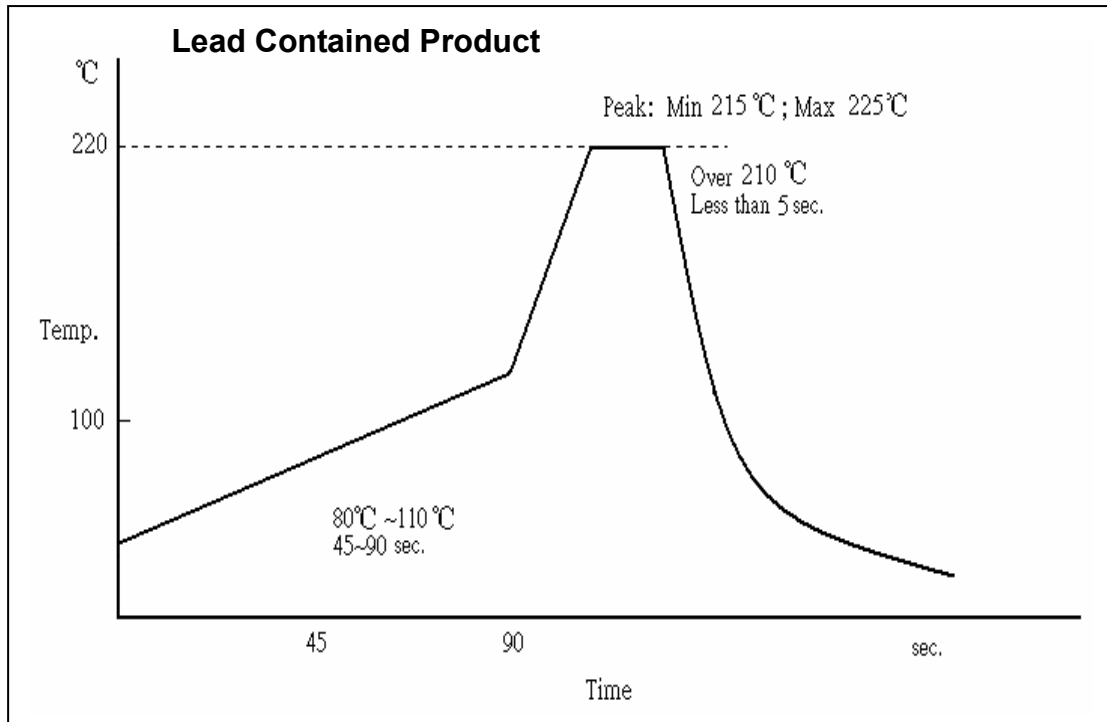

Per-heat : 80°C ~ 110°C.

Per-heat time : 45 seconds ~ 90 seconds

Lead Contained Solder Temperature : 220°C±5°C

Dwell Time : Less than 5 seconds

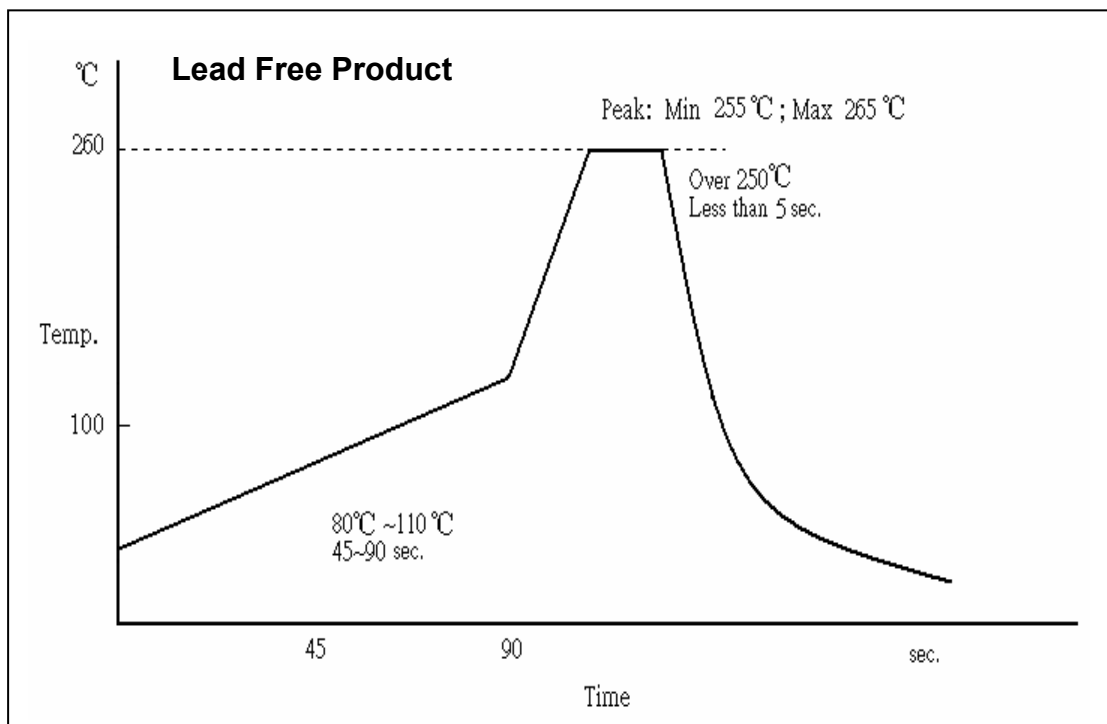

Per-heat : 80°C ~ 110°C.

Per-heat time : 45 seconds ~ 90 seconds

Lead Free Solder Temperature : 260°C±5°C

Dwell Time : Less than 5 seconds

FRX Series tape and reel specifications (dimensions in millimeters)

Product availability : FRX005-60F ~ FRX185-60F

Dimension Description	MARK	Dimension	
		Dim (mm)	Tol. (mm)
Carrier tape width	W	18	± 1.0
Hold down tape width	W4	11	min
Top distance between tape edges		3	max
Sprocket hold position	W5	9	± 0.75
Sprocket hold diameter	D0	4	± 0.2
Abscissa to plane (straight lead)	H	18.5	± 3.0
Abscissa to plane (kinked lead)	H0	16	± 1.0
Abscissa to top	H1	32.2	max
Overall width with lead protrusion FRX005-60F~FRX185-60F	C1	45.0	max
Overall width without lead protrusion FRX005-60F~FRX185-60F	C2	44.3	max
Lead protrusion	L1	1.0	max
Protrusion of cutout	L	8~10	max
Protrusion beyond hold-down tape	l2	not specified	
Sprocket hold pitch	P0	12.7	± 0.3
Device pitch : FRX005-60F ~ FRX090-60F		12.7	± 0.3
Device pitch : FRX110-60F ~ FRX185-60F		25.4	± 0.61
Type thickness	t	0.9	max
Type thickness with splice		2.0	max
Body lateral deviation	Δh	0	± 2.0
Body tape plane deviation	ΔP	0	± 2.0
Ordinate to adjacent component lead FRX005-60F ~ FRX090-60F	P1	3.81	± 0.7
Ordinate to adjacent component lead FRX110-60F ~ FRX185-60F	P1	7.62	± 0.7
Lead spacing : FRX005-60F ~ FRX090-60F	F	5.1	± 0.6
Lead spacing : FRX110-60F ~ FRX185-60F	F	5.1	± 1.0
Reel width	W2	56	max
Reel diameter	a	370	max
Space between flanges less device	W1	54	max
Arbor hold diameter	c	26	± 12
Core diameter	n	91	max

FRX Series tape and reel specifications (dimensions in millimeters)
Product availability : FRX005-60F ~ FRX185-60F

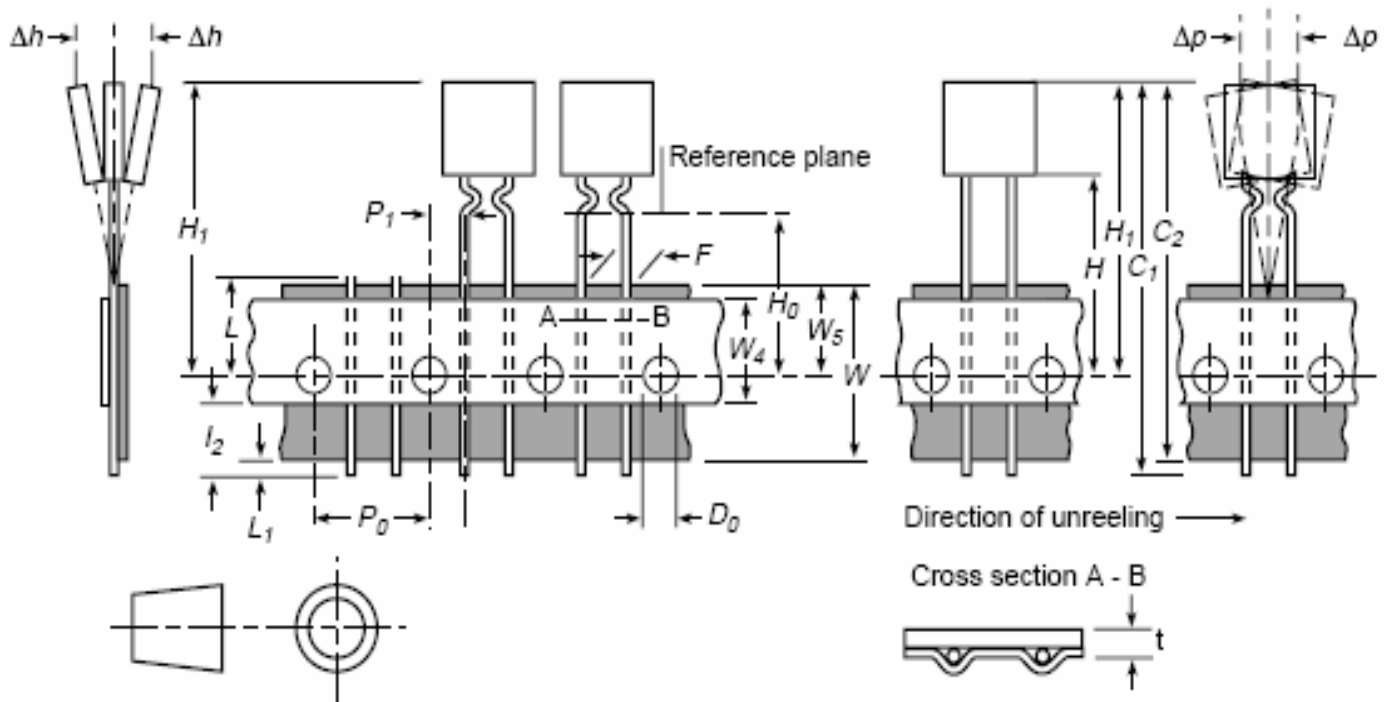

Figure 1 Taped Component Dimensions

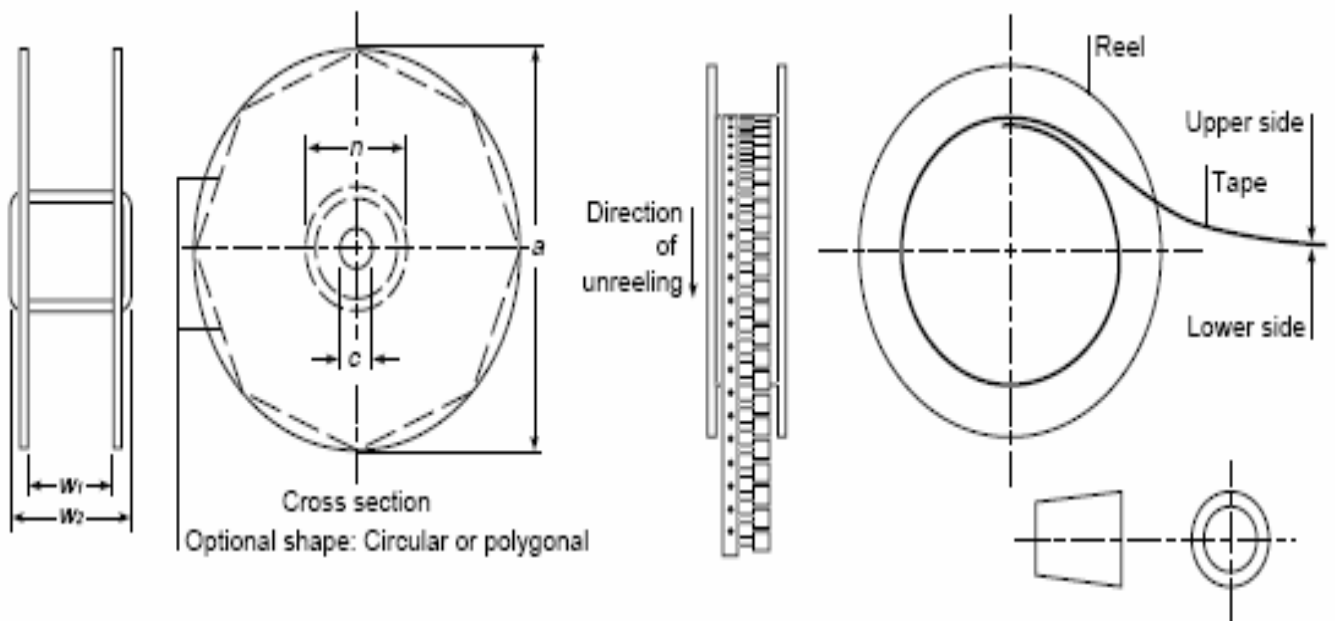

Figure 2 Reel Dimensions

Standard Package

P/N	Pcs /Bag	Reel/Tape
FRX005-60F	500	3000
FRX010-60F	500	3000
FRX017-60F	500	3000
FRX020-60F	500	3000
FRX025-60F	500	3000
FRX030-60F	500	3000
FRX040-60F	500	3000
FRX050-60F	500	3000
FRX065-60F	300	3000

P/N	Pcs /Bag	Reel/Tape
FRX075-60F	300	3000
FRX090-60F	300	3000
FRX110-60F	300	1500
FRX135-60F	200	1500
FRX160-60F	200	1500
FRX185-60F	200	1500
FRX250-60F	100	1000
FRX300-60F	100	1000
FRX375-60F	100	1000