

MASTECH®

MS8321D

Digital Multimeter

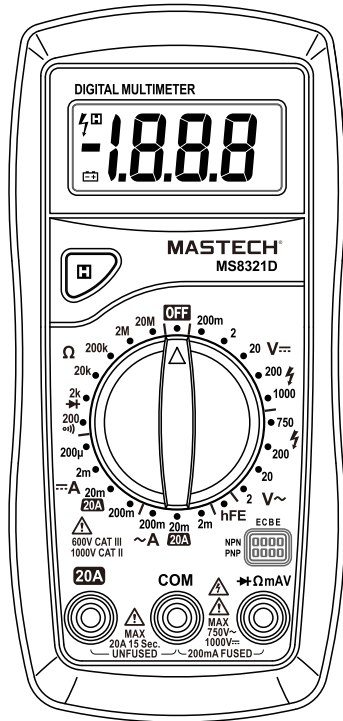

CAT III
600V

CAT II
1000V

CONTENTS

1. Introduction	1
1.1 Safety Guidelines.....	1
1.1.1 Precautions.....	1
1.1.2 Safety Symbols.....	2
1.1.3 Maintenance.....	3
2. Instrument Description	3
2.1 Front Panel.....	3
2.2 Display.....	5
2.3 Hold Button	5
2.4 Rotary Switch	5
2.5 Input Jacks	5
2.6 Automatic Power Off.....	5
2.7 Accessories	5
3. Specifications.....	6
3.1 General Specifications.....	6
3.2 Technical Specifications.....	7
3.2.1 DC Voltage.....	7
3.2.2 AC Voltage	7

CONTENTS

3.2.3 DC Current	8
3.2.4 AC Current	8
3.2.5 Resistance.....	9
3.2.6 Continuity/Diode Test.....	9
3.2.7 hFE Transistor Gain.....	9
4. Operating Instructions.....	10
4.1 DC/AC Voltage.....	10
4.2 Resistance	10
4.3 DC/AC Current	11
4.4 Diodes.....	11
4.5 hFE Transistor Gain.....	12
4.6 Continuity.....	12
5. Maintenance.....	13
5.1 Cleaning the Meter.....	13
5.2 Replacing Test Leads	13
5.3 Replacing the Battery and Fuses	14

1. Introduction

This digital multimeter complies with international safety standards EN61010-1 electrical safety requirements for electronic measuring instruments and handheld digital multimeters; CAT III 600V/CAT II 1000V and pollution degree of 2. Read all instructions carefully before using the meter and follow all relevant safety standards.

1.1 Safety Guidelines





To ensure safe usage of this instrument, please read the following carefully:

1.1.1 Precautions

- All the instrument to warm up for 30 sec. before measurement.
- Inspect the case before use. Check for cracks in the casing and the insulation around the input sockets.
- Only use the test leads provided with the meter. If leads are damaged or need to be replaced, use similar leads with matching specifications.
- Ensure the meter works properly by testing a known voltage source first. If not working properly, the protective equipment may be damaged; have the meter serviced before using.
- Do not place meter in a strong magnetic field; this may cause false readings.
- Do not place the meter in any environment with high pressure, high temperature, dust, explosive gas or vapor.
- Make sure the test leads are in the correct input jacks before measurement.
- Choose the highest range when the value to be measured is unknown beforehand.
- Never exceed the protection limit values indicated in the specifications for each range of measurement.

- Do not perform a voltage test using the 10A input jack.
- Always be careful when working with voltages above 60V dc or 30V ac rms. Keep fingers behind the probe barriers when making voltage measurements.
- When connecting the test leads to a measurement circuit, connect the common lead first, then the live lead. Reverse when disconnecting.
- Disconnect leads from circuit before switching functions/ranges.
- Disconnect leads from circuit before testing transistors.
- Turn off power to circuit and discharge all capacitors before making resistance, continuity or diode measurements.
- Before making current measurements, turn off power to the circuit, break the circuit, connect the leads in series across the break, then turn the power back on for measurement.
- When the "⚡" symbol appears, replace the batteries to avoid incorrect readings.

1.1.2 Safety Symbols

	Note-Important safety information, refer to the instruction manual.
	Earth (ground) TERMINAL
	Equipment protected throughout by double insulation or reinforced insulation.
	Both direct and alternating current
	Fuse

CAT III: MEASUREMENT CATEGORY III is applicable to test and measuring circuits connected to the distribution part of the building's low-voltage MAINS installation.

CAT II: MEASUREMENT CATEGORY II is applicable to test and measuring circuits connected directly to utilization points (socket outlets and similar points) of the low-voltage MAINS installation.

1.1.3 Maintenance

- Maintenance/calibration should only be performed by professionals.
- For continued protection against fire, replace fuse only with the specified voltage and current ratings listed in the manual: F1 250mA/250V F2 10A/250V
- Before opening the case, always disconnect test leads from all energized circuits.
- Never use the meter unless the back cover is in place and fastened securely.
- If any abnormality is observed, stop using the meter and send it in for repair.
- If the meter is not going to be used for an extended period of time, remove the batteries and avoid storing in a hot/humid environment.

2. Instrument Description

2.1 Front Panel

1. Display
2. Hold Button
3. Rotary Switch
4. Input Jacks
5. hFE socket

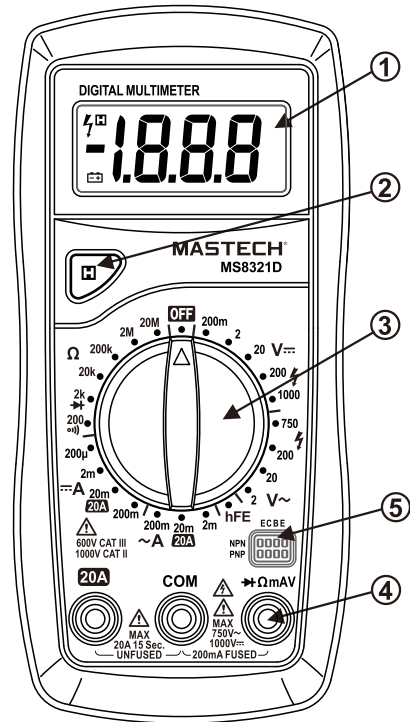

MASTECH®

2.2 Display

3 ½ digit, 15mm LCD display

2.3 Hold Button

- Press to keep the current reading on the display.
- Press the button again to return to normal display.

2.4 Rotary Switch

The rotary switch is used to switch between functions/ ranges. Functions are: voltage, current, resistance, diode, continuity and transistor gain.

2.5 Input Jacks

- **VΩmA**: voltage, resistance, mA current, diode, continuity measurement input (red test lead)
- **COM**: Common lead input (black test lead)
- **20A**: Greater than 200mA current measurement input (red test lead)

2.6 Automatic Power Off

After 15 min. of non-use the meter will automatically turn itself off. To turn the meter back on, move the rotary switch to any position except off.

2.7 Accessories

- Manual 1 piece
- Test Leads 1 pair
- Case 1 piece
- 9V Battery 1 piece

MASTECH®

3. Specifications

3.1 General Specifications

Function	Range
Safety Rating	600V CAT III / 1000V CAT II
Pollution degree	2
Operating Altitude	<2000m
Operating Temperature/ Humidity	0~40°C, (<80% RH)
Storage Temperature/ Humidity	-10~60°C, (<70% RH, remove battery)
Temperature coefficient	0.1% accuracy/0°C (<18°C or >28°C)
Max. Input between terminals and earth ground	600V DC or AC rms
Fuse Protection	F1 250mA/250V F2 10A/250V
Sample Rate	Approx. 3 times/sec,
Display	3 ½ digit LCD display, max. reading: 1999.
Over-range Indication	display shows "1"
Low Battery Indication	When battery voltage drops below the normal operating voltage, "⊖" will appear on the display.
Polarity Indication	Display automatically displays "-"
Power	9V battery NEDA 1604 or 6F22
Dimensions	158(L)x74(W)x36(H) mm.
Weight	approx. 220g (including battery)

3.2 Technical Specifications

Accuracy: \pm (% of reading + digits) at 18°C~28°C with a relative humidity of <80%; guaranteed for a period of one year.

3.2.1 DC Voltage

Measuring range	Resolution	Accuracy
200mV	0.1mV	\pm (0.7% of reading +1 digits)
2V	1mV	
20V	10mV	
200V	100mV	
1000V	1V	\pm (0.8% of reading +2 digits)

Input impedance: 10M Ω

Max. input voltage: 750V DC or AC rms.

200mV range: 250V DC or AC rms.

3.2.2 AC Voltage

Measuring range	Resolution	Accuracy
2V	1mV	\pm (0.8% of reading +3 digits)
20V	10mV	
200V	100mV	
750V	1V	\pm (1.2% of reading +3 digits)

Input Impedance: 10M

Max. Input Voltage: 750V DC or AC rms.

Frequency Response: 40Hz~400Hz rms sine wave (avg. responding)

3.2.3 DC Current

Measuring range	Resolution	Accuracy
200 μ A	0.1 μ A	\pm (1.0% of reading +3 digits)
2mA	1 μ A	
20mA	10 μ A	
200mA	0.1mA	\pm (1.5% of reading +1 digits)
20A	10mA	\pm (2.0% of reading +5 digits)

Overload Protection: F1 250mA/250V F2 10A/250V

Max. Input Current: mA: 200mA DC or AC rms.

20A: continuous (do not exceed 15 sec.)

3.2.4 AC Current

Measuring range	Resolution	Accuracy
2mA	1 μ A	\pm (1.2% of reading +5 digits)
20mA	10 μ A	
200mA	0.1mA	\pm (1.8% of reading +5 digits)
20A	10mA	\pm (3.0% of reading +10 digits)

Overload Protection: F1 250mA/250V F2 10A/250V

Max. Input Current: mA: 200mA DC or AC rms.

20A: continuous (do not exceed 15 sec.)



Frequency Response: 40Hz~400Hz rms sine wave (avg. responding)

3.2.5 Resistance

Measuring range	Resolution	Accuracy
200Ω	0.1Ω	±(1.0% of reading +1 digits)
2kΩ	1Ω	
20kΩ	10Ω	
200kΩ	100Ω	
2MΩ	1kΩ	
20MΩ	10kΩ	±(1.0% of reading +5 digits)

Overload Protection: 250V DC or AC rms; do not exceed 15 sec. continuous measurement.

3.2.6 Continuity/Diode Test

Function	Description	
	If measured resistance is less than 60Ω, the buzzer will sound.	Open circuit voltage: approx. 2.8V
	The display shows the approx. forward voltage drop	Forward DC current: approx. 1mA Reverse DC voltage: approx. 3V

Overload Protection: 250V DC or AC rms; do not exceed 15 sec. continuous measurement.

3.2.7 hFE Transistor Gain

Function	Description	
hFE	Displays approx. hFE transistor gain (0-1000)	Base current: approx. 10μA Vce: approx. 2.8V

4. Operating Instructions

4.1 DC/AC Voltage

 **Warning**

**Max. input voltage: 750V DC or AC rms (200mV range is 250V DC or AC rms).
Do not exceed the protection limits to prevent electric shock and/or damage to the meter.**

- Turn the rotary switch to the proper voltage range.
- Connect the red test lead to the V input jack and the black test lead to the COM jack.
- Connect the leads to the voltage source or circuit under test.
- Read the measured voltage on the display. When measuring DC voltage, the display will show the polarity of the red lead.
- If the display only shows "1", it indicates the input exceeds the selected range. Move the rotary switch to a higher range.

4.2 Resistance

 **Warning**

Turn off all power and discharge all capacitors completely before making resistance measurements.

- Turn the rotary switch to the proper voltage range.
- Connect the red test lead to the Ω input jack and the black test lead to the COM jack.
- Connect the leads to the resistance or circuit under test and read the measured resistance on the display.
- When measuring low resistances, short the test leads and record the measurement. Then connect the leads to the resistance to be measured and subtract the shorted resistance.

Note:

- When the measured resistance is greater than $1M\Omega$, wait a few seconds for readings to stabilize. This is normal for high resistance measurements.
- When the circuit is open or leads not connected, the display will show “1”.

4.3 DC/AC Current

Warning



To avoid personal injury, damage to the meter or device under test, always be sure to have the rotary in the correct position and leads in the correct jack before making current measurements.

- Turn the rotary switch to the proper current range.
- Connect the black test lead to the COM jack. If the current to be measured is less than $200mA$, connect the red test lead to the mA jack; if the current to be measured is greater than $200mA$, connect the red test lead to the 20A jack.
- Break the circuit and connect the leads in series with the circuit under test.
- Read the measured current on the display. When measuring DC current, the display will show the polarity of the red lead.
- If the display only shows “1”, it indicates the input exceeds the selected range. Move the rotary switch to a higher range.

4.4 Diodes

Warning

Turn off all power and discharge all capacitors completely before testing diodes.

- Turn the rotary switch to the  position.
- Connect the red test lead to the  input jack and the black test lead to the COM jack.
- Connect the red lead to the anode (+) and the black lead to the cathode (-) of the diode.
- The meter displays the forward voltage drop of the diode. If the leads are reversed, the display will show ‘1’.

4.5 hFE Transistor Gain

Warning

To prevent damage to the meter, make sure the transistor is not connected to a circuit before making measurements.

- Turn the rotary switch to the hFE position.
- Set the rotary switch to hFE range.
- Determine whether the transistor to be tested is NPN or PNP type and locate the Emitter, Base and Collector leads.
- Insert leads of the transistor into proper holes of the hFE socket.
- The meter will show the approx. hFE value at test condition of base current $10\mu A$ and $V_{ce} 2.8V$.

4.6 Continuity

Warning

Turn off all power and discharge all capacitors completely before testing continuity.

- Turn the rotary switch to the  position.
- Connect the red test lead to the Ω input jack and the black test lead to the COM jack.
- Connect the leads to the circuit under test.
- If the measured resistance is less than 60Ω , the buzzer will sound.

5. Maintenance

5.1 Cleaning the Meter

⚠ Warning

Before opening the back cover, turn off the meter and disconnect test leads from any circuit.

Clean meter with a damp cloth and mild detergent; do not use chemical solvents on the meter. Dirt or moisture on the input jacks can affect the reading of the meter.

To clean the input jacks:

- Turn the rotary switch to OFF and remove test leads.
- Remove all dirt from the input jacks.
- Use a detergent or lubricant with a cotton swab to clean the jacks. Use a new cotton swab for each jack to prevent cross contamination.

5.2 Replacing Test Leads

Replace test leads if leads become damaged or worn.

⚠ WARNING

Use meet EN 61010-031 standard, rated CAT III 600V, or better test leads.

5.3 Replacing the Battery and Fuses

1. Under normal conditions, it is unnecessary to replace the fuse. Don't replace it until the probes are unplugged and the power is shut down. Take out the two screws of the rear cover to remove the housing.
2. The specification of the fuse is:
F1 250mA/250V F2 10A/250V
The replacement should be of the same specification.
3. The battery for this multimeter is 9V NEDA 1604 or 6F22. The replacement should be of the same specification.
4. Don't put the instrument into use until the rear cover is screwed after replacing battery or fuse.

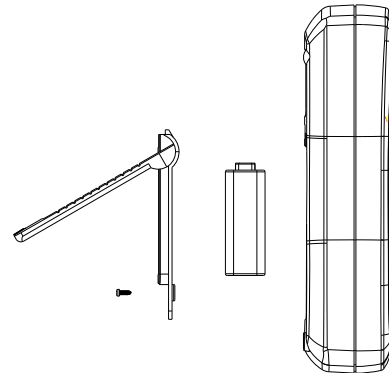



R-00-05-1101