

GNS-23011Axx-Bxx (SINGLE DIGIT LED DISPLAY)

GNS-23011 Series

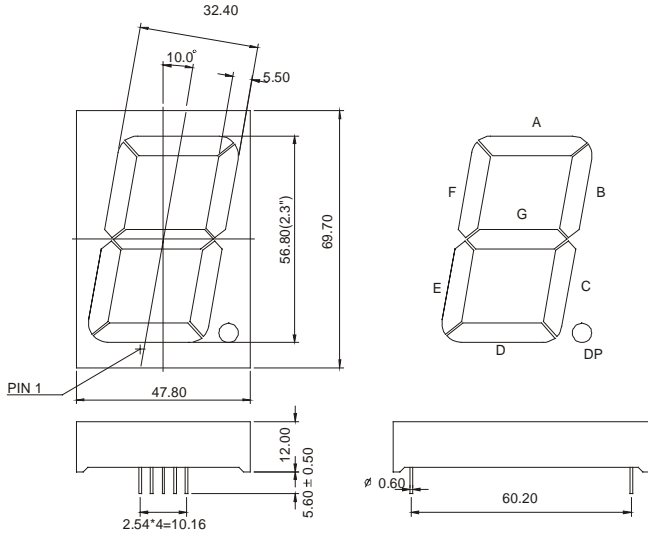

GNS-23011AEG

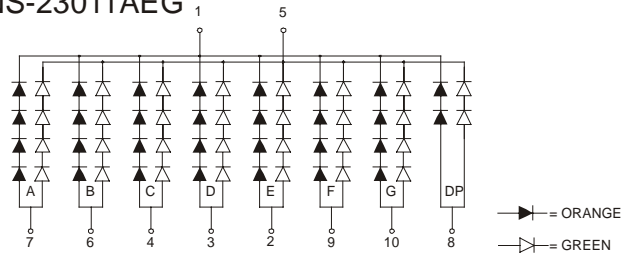

GNS-23011BEG

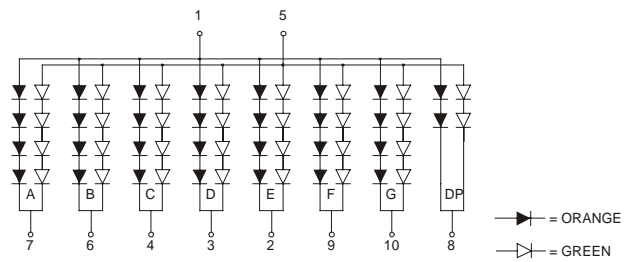

Features:

*2.3 INCH HIGH CHARACTER.

*EXCELLENT CHARACTER APPEARANCE.

*COMMON CATHODE OR COMMON ANODE.

*I.C. COMPATIBLE

*LOW POWER CONSUMPTION.

Part Number	EMITTED COLOR		Common Cathode or Common Anode	Peak Wavelength (nm)	Vf (v) Typ	If (mA)	Intensity Per Segment (mcd)	
							Min.	Typ.
GNS-23011ASG	GaAlAs	Super Red	Common Cathode	660	1.8	20	40	52
	Gap	Green		565	2.1	20	32	44
GNS-23011AEG	GaAsP	Hi.effi Red		635	2.0	20	36	48
	Gap	Green		565	2.1	20	32	44
GNS-23011BSG	GaAlAs	Super Red	Common Anode	660	1.8	20	40	52
	Gap	Green		565	2.1	20	32	44
GNS-23011BEG	GaAsP	Hi.effi Red		635	2.0	20	36	48
	Gap	Green		565	2.1	20	32	44