

承认书

SPECIFICATION FOR APPROVAL

客户名称

CUSTOMER

产品名称

DESCRIPTION

PUSH BUTTON SWITCH

产品编号

MODEL NO.

GQ12H2-10L

送样日期

ISSUE DATE

客户/签批 (CUSTOMER/APPROVAL)

采购部 PURCHASE DEPT	工程部 ENGINEER DEPT	品质部 QUALITY DEPT

戴尔/签批 (YUEQING/APPROVAL)

DGN.制表人	CKD.校对	APPD.审核



	乐清市戴尔电子有限公司 YUEQING DAIER ELECTRON CO.,LTD		规 格 书 SPECIFICATION		编号 No.	
					版本号 ERSION	A0
产品名称 ERIES	按钮开关 PUSH SWITCH		产品型号 TYPE	GQ12H2-10L		
日期 DATE	2017.4.3		页码 PAGE	1 / 4		

项目 ITEM	测试条件 TEST CONDITIONS	要求 REQUIREMENT
---------	----------------------	----------------

<p>1、温度范围</p> <p>Temperature Range</p> <p>使用温度范围: -25 °C ~ +55°C</p> <p>Operating Temperature Range -25°C ~+55°C</p> <p>2、测试环境条件:</p> <p>Test Circumstance Condition:</p> <p>环境温度: 25°C ± 5°C</p> <p>Ambient temperature : 25°C ± 5°C</p> <p>相对湿度: 45%~85%</p> <p>Relative humidity : 45%~85%</p> <p>空气压力: 102 千帕</p> <p>Air pressure: 102KPa</p> <p>3、外观、结构和尺寸</p> <p>Appearance, Structure and Dimension</p> <p>3.1 外观:</p> <p>Appearance:</p> <p>外观美观、没有生锈、伤痕、电镀不良、破裂, 剥离现象。动作正常, 换位清晰。</p> <p>Nice appearance; Free from Rust, Scratch, Bad plated, Denude; Smooth action, Clear conversion.</p> <p>3.2 结构和尺寸:</p> <p>Structure and Dimension:</p> <p>参照有关外形图</p> <p>Reference to the relative</p> <p>4、额定值: 3A 36VDC; 3A 250VAC</p> <p>Rating: 3A 36VDC; 3A 250VAC</p>		
---	--	--

	乐清市戴尔电子有限公司 YUEQING DAIER ELECTRON CO.,LTD	规格书 SPECIFICATION		编号 No.	
				版本号 ERSION	A0
产品名称 ERIES	按钮开关 PUSH SWITCH	产品型号 TYPE	GQ12H2-10L		
日期 DATE	2017.4.3	页码 PAGE	2 / 4		

项目 ITEM	测试条件 TEST CONDITIONS	要求 REQUIREMENT
---------	----------------------	----------------

5、机械性能 Mechanical Performance			
5.1	动作力 Operating Force	<p>开关垂直于操作方向放置，在按钮一侧逐渐施力，测量开关导通所需的最大力度。</p> <p>Vertical placing the switch with the direction of switch operation, then gradually increasing the force, measure demanded maximum force that switch continuity.</p>	依图所示
5.2	端子强度 Terminal strength	<p>在端子的顶部施加一向内推的 40N 静负荷，持续 60 秒。</p> <p>Enforce push-inward static 40N load on the top of terminal, lasting 60 seconds</p>	<p>端子无损伤，脱落，开关功能动作正常。</p> <p>No damage, leafing, switch function action is normal.</p>
5.3	可焊性试验 Solder-Ability	<p>将端子浸入熔融的锡槽内，温度为 235±5℃，时间为 2±0.5 秒。</p> <p>Immerse the terminal to the molten solder tank, temperature reach to 235±5℃,time reach to 2±0.5 seconds</p>	<p>浸入的部分 90% 以上表面被锡覆盖。</p> <p>90% of the surface will be covered by solder.</p>
5.4	耐焊性试验 Soldering resistance test	<p>端子的焊接部分浸入温度为 260±5℃ 熔融的锡炉内 2±0.5 秒。</p> <p>The welding part of terminal immerse molten solder at a temperature of 260±5℃ for 2±0.5 seconds.</p> <p>手工烙铁焊接：焊接温度 350±5℃，焊接时间 2±0.5 秒。焊接时在端子上不能施加异常压力。</p> <p>Manual iron welding: welding temperature: 350±5℃,welding time: 2±0.5 seconds. When welding, can't enforce anomaly pressure on the terminal.</p>	<p>本体无变形，能满足于机械、电气性能</p> <p>Without deformation of base, can satisfy mechanical, electronic performance.</p>
6、电气性能 Electronic Performance			
6.1	接触电阻 Contact resistance	<p>在 1KHz 小电流下测量。</p> <p>Being measured at 1KHz small current.</p>	50 毫欧姆以下 50mΩ MAX.

	乐清市戴尔电子有限公司 YUEQING DAIER ELECTRON CO.,LTD	规格书 SPECIFICATION		编号 No.	
				版本号 ERSION	A0
产品名称 ERIES	按钮开关 PUSH SWITCH	产品型号 TYPE	GQ12H2-10L		
日期 DATE	2017.4.3	页码 PAGE	3 / 4		

项目 ITEM		测试条件 TEST CONDITIONS	要求 REQUIREMENT
6.2	绝缘电阻 Insulation resistance	在端子之间和端子与外壳之间施加 DC500V，一分钟后测量。 Measurement shall be made enforcing DC500V between terminals and between terminals and frame for 1 minute.	100 兆欧姆以上 100MΩ MIN.
6.3	耐电压 Withstand voltage	在极与极之间施加 AC1500V，0.5mA、1min，在极与操动件之间施加 AC1000V，0.5mA 1min。 Enforce AC1500V, 0.5mA between pole and pole in 1min ,enforce AC1000V , 0.5mA between pole and frame in 1min	无击穿现象出现。 No breakdown.
7、耐久性能 Durability			
7.1	机械寿命 Mechanical life	每分钟 30 次的速度连续工作 500,000 次 Operating 500,000 cycles at a rate of 30cycles per minute	外观，动作功能正常
7.2	电气寿命 Electrical life	额定负载条件下,每分钟 30 次的速度操作 ≥ 50,000 次.工作条件: 3A 36VDC Operating ≥ 50,000 cycles at a rate of 30cycles per minute under rate loading on conaition that the voltage is 36VDC and the current is 3A	1.耐电压≥1500VAC/1min Withstand voltage ≥1500VAC/1min
8、耐候性 Weather Ability			
8.1	耐高温试验 Heat test	在 55±2℃环境中放置 72 小时,再放在正常环境中 60 分钟后进行测试。 Putting at 55±2℃ for 72 hours. Test after keeping in normal condition for 60 minutes.	1、接触电阻 50 毫欧以下 Contact resistance 50mΩ MAX. 2、绝缘电阻 100 兆欧以

	乐清市戴尔电子有限公司 YUEQING DAIER ELECTRON CO.,LTD	规格书 SPECIFICATION		编号 No.	
				版本号 ERSION	A0
产品名称 ERIES	按钮开关 PUSH SWITCH	产品型号 TYPE	GQ12H2-10L		
日期 DATE	2017.4.3	页码 PAGE	4 / 4		

项目 ITEM	测试条件 TEST CONDITIONS	要求 REQUIREMENT
---------	----------------------	----------------

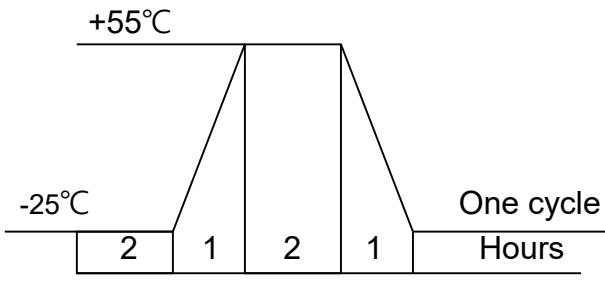
8.2	耐湿试验 Anti-humid test	在温度为 $40 \pm 2^{\circ}\text{C}$ ，相对湿度为 91%-95%RH 的环境中放置 96 小时，再放在正常环境中 60 分钟后进行测试。 Putting at $40 \pm 2^{\circ}\text{C}$, 91%~95%RH for 96 hours. Test after keeping in normal condition for 60 minutes.	上 Insulation resistance 100MΩ MIN. 3、耐电压 1500VAC, 0.5mA、5S 无击穿 Withstand voltage 1500VAC,0.5mA,5S No breakdown. 4、无任何迹象显示机械 及电气性能之损坏 No sign of damage mechanical and electronic performance.
8.3	耐低温试验 Anti-low temperature test	在 $-25 \pm 3^{\circ}\text{C}$ 的环境中放置 16 小时，再放在正常环境中 60 分钟后进行测试。 Putting at $-25 \pm 3^{\circ}\text{C}$ for 16 hours. Test after keeping in normal condition for 60 minutes.	
8.4	温度交变试验 Temperature cycling test	在如图示之环境中，循环 5 次后，再置于正常环境中，30 分钟后进行测试。 In FIG. For 5 cycles, test after kept in normal condition for 30 minutes. 	

9、包装、储存			
9.1	包装 Packing	每 100 只产品装 1 盒,1 纸箱装 2000 只产品,每个箱用胶带封口,并用扎带捆牢固;纸箱要干燥,盒子在纸箱内无晃动	100pcs/Box; 2000pcs/Carton
9.2	储存 Storage	包装成箱的开关,应在环境温度 $-10^{\circ}\text{C} \sim 40^{\circ}\text{C}$ 、相对湿度不大于 80%、周围没有酸性、碱性或其他腐蚀性气体的房间内储存。	Should be stored in where the ambient temp is $-10^{\circ}\text{C} \sim 40^{\circ}\text{C}$, Relative humidity $\leq 80\%$, and no acid, alkaline or other corrosive gases nearby

更改	说明	修改人	审核
----	----	-----	----

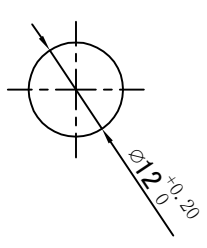
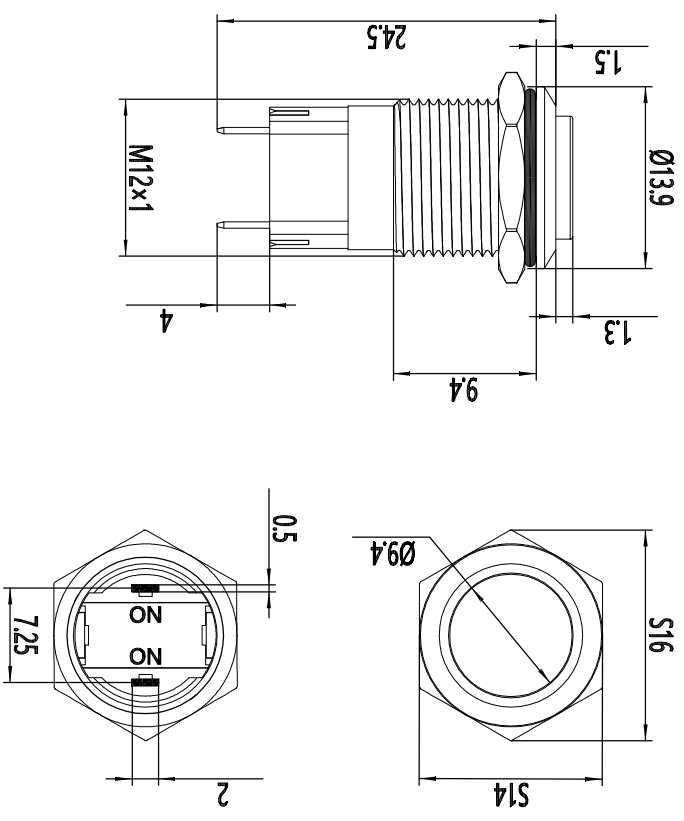
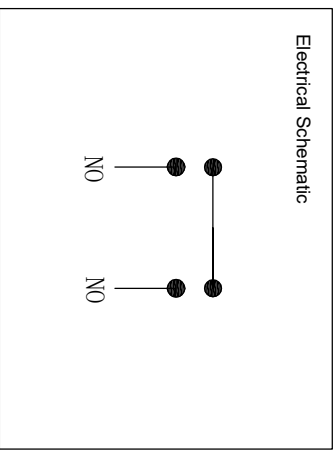

PANEL CUTOUT
MAX.PANEL THICKNESS
7mm

Specifications

Function: LATCHING
Contact Arrangement: SPST 1NO
Mounting Type: Threaded Front Panel Mount
Torque For Threaded Body: 5-14Nm
LED Illumination: No LED

Mechanical

Operating Life: ≥ 500,000 Cycles
Total Travel: About 1.6mm
Operating Force: 2.5±1N

Electrical

Contact Rating: 3A 250VAC ; 6A 125VAC
3A 36VDC ; 6A 12VDC
Operating Life: ≥50,000 Make-and-Break Cycles at Full Load
Dielectric Strength: 2,000V RMS @Sea Level
Insulation Resistance: 1,000MΩ Min @500VDC
Contact Resistance: 50mΩ max

Materials

Bushing: Stainless Steel / Brass Nickel Plated / Aluminum Alloy
Base: PBT (UL94-V0)
Actuator: Stainless Steel / Brass Nickel Plated / Aluminum Alloy
Internal Assembly: POM/PA66
Spring: Steel
Sealing/O-Ring: Silicone
Terminals: Brass with Gold Plated
Contact: Copper Silver Plated

Operating Environment

Operating Temperature: -25℃ to +55℃
Sealing/Protection: IP65

NOTE: Specifications and materials listed above are for switches with standard options.
For information on specific and custom switches, please contact Customer Service.

 乐清市戴尔电子有限公司 YUBEIQING DAIER ELECTRON CO., LTD			
DR. 制图	APPD 审核		
DE. 设计	CHKD 校对		
DIMENSIONS	Tolerance	SCALE	UNIT
0.00 ~ 10.00mm	±0.15mm	比例 1.5/1	单位 mm
10.01 ~ 30.00mm	±0.20mm	TITLE 名称 PUSH BUTTON SWITCH	
30.01 ~ 80.00mm	±0.25mm	DWG NO. GQ12H2-10L	
80.01 ~ 150.00mm	±0.30mm	FILE NAME 档案名称	
150.01mm ¹	±0.40mm	SHEET 张	REV. 更改
		1 / 1	1