

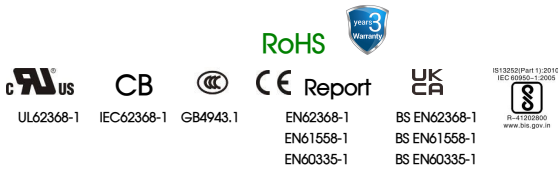

FEATURES

- Universal 80 - 305VAC or 100 - 430VDC input voltage
- Accepts AC or DC input (dual-use of same terminal)
- Operating ambient temperature range: -40°C to +85°C
- Compact size, high power density
- Low standby power consumption, high efficiency
- High I/O isolation test voltage up to 4000VAC
- Low ripple & noise
- Output short circuit, over-current, over-voltage protection
- OVC III (meet EN62477)
- Operating altitude up to 5000m



LM100-23BxxR2 series is the ultra-small Mornsun second-generation new industrial standard enclosed power supply, which has innovated the industrial power supply standard from the aspect of dimension, performance, technology and structure. It features universal AC input and at the same time accepts DC input voltage, cost-effective, low no load power consumption, high efficiency, high reliability and reinforced isolation. These converters offer excellent EMC performance and meet IEC/EN61000-4, CISPR32/EN55032, UL/IEC/EN/BS EN62368, EN60335, EN61558, EN62477, GB4943.1 standards and they are widely used in areas of industrial, LED, street light control, electricity, security, telecommunications, smart home etc. For extremely harsh EMC environment, we recommend using the application circuit show in Design Reference of this datasheet.

Selection Guide

Certification	Part No.*	Output Power (W)	Nominal Output Voltage and Current (Vo/Io)	Output Voltage Adjustable Range (V)	Efficiency at 230VAC (%) Typ.	Capacitive Load (uF) Max.
UL/IEC/CCC/ EN/BIS	LM100-23B05R2	90	5V/18A	4.75-5.75	87.0	10000
	LM100-23B12R2	102	12V/8.5A	11.4-13.8	90.0	6800
	LM100-23B15R2	105	15V/7.0A	14.25-17.25	90.0	3300
	LM100-23B24R2	108	24V/4.5A	22.8-27.6	90.5	2200
	LM100-23B36R2	100.8	36V/2.8A	34.2-41.4	90.5	1000
	LM100-23B48R2	110.4	48V/2.3A	43.2-52.8	91.5	470
UL/IEC/ CCC/EN	LM100-23B54R2	102.6	54V/1.9A	51.3-56.7	91.5	220

Note: *1. Use suffix "C" for terminal with protective cover, suffix "Q" for bottom conformal coating and "QQ" for both sides conformal coating;
2. The product picture is for reference only. For details, please refer to the actual product.

Input Specifications

Item	Operating Conditions	Min.	Typ.	Max.	Unit	
Input Voltage Range	AC input	80	--	305	VAC	
	DC input	100	--	430	VDC	
Input Voltage Frequency		47	--	63	Hz	
Input Current	115VAC	--	--	3	A	
	230VAC	--	--	1.5		
Inrush Current	115VAC	Cold start	--	35		--
	230VAC		--	65		--
Leakage Current	277VAC	<0.75mA				
Hot Plug		Unavailable				

Output Specifications

Item	Operating Conditions	Min.	Typ.	Max.	Unit	
Output Voltage Accuracy	Full load range	5V	--	±2	--	%
		12V/15V/24V/36V/48V/54V	--	±1	--	

Line Regulation	Rated load	--	±0.5	--	
Load Regulation	0% - 100% load	5V	--	±1	%
		12V/15V/24V/36V/48V/54V	--	±0.5	
Ripple & Noise*	230V, Rated load; 20MHz bandwidth (peak-to-peak value)	5V	--	150	mV
		12V/15V	--	120	
		24V	--	150	
		36V/48V/54V	--	200	
Temperature Coefficient		--	±0.03	--	%/°C
Minimum Load		0	--	--	%
Stand-by Power Consumption		--	0.3	0.5	W
Hold-up Time	115VAC	--	10	--	ms
	230VAC	--	55	--	
Short Circuit Protection	Recovery time <5s after the short circuit disappear.	Hiccup, continuous, self-recovery			
Over-current Protection		115% - 200% Io, Hiccup, self-recovery			
Over-voltage Protection	5V	≤7.5VDC (Clamp, self-recovery)			
	12V	≤19.2VDC (Hiccup, self-recovery)			
	15V	≤24VDC (Hiccup, self-recovery)			
	24V	≤38.4VDC (Hiccup, self-recovery)			
	36V	≤57.6VDC (Hiccup, self-recovery)			
	48V	≤60VDC (Clamp, self-recovery)			
	54V	≤70VDC (Hiccup, self-recovery)			
Note: *The "Tip and barrel method" is used for ripple and noise test, output parallel 47μF electrolytic capacitor and 0.1μF ceramic capacitor, please refer to Enclosed Switching Power Supply Application Notes for specific information.					

General Specifications

Item	Operating Conditions		Min.	Typ.	Max.	Unit
Isolation	Input - ⊕	Electric strength test for 1min., leakage current <10mA	2000	--	--	VAC
	Input - output	Electric strength test for 1min., leakage current <5mA	4000	--	--	
	Output - ⊕	Electric strength test for 1min., leakage current <5mA	1250	--	--	
Insulation Resistance	Input - ⊕	Test voltage at 500VDC	100	--	--	MΩ
	Input - output		100	--	--	
	Output - ⊕		100	--	--	
Operating Temperature		-40	--	+85	°C	
Storage Temperature		-40	--	+85		
Operating Humidity	Non-condensing	20	--	90	%RH	
Storage Humidity		10	--	95		
Switching Frequency		--	80	--	kHz	
Power Derating	+45°C to +70°C	5V	1.60	--	--	%/°C
	+50°C to +70°C	12V/15V/24V/36V/48V/54V	2.00	--	--	
	+70°C to +85°C		2.00	--	--	
	-40°C to -30°C		5.00	--	--	
	80VAC - 100VAC		1.25	--	--	%VAC
	277VAC - 305VAC		0.71	--	--	
Safety Standard	5V/12V/15V/24V/36V/48V	UL/IEC62368-1, GB4943.1, IS13252 (Part1) safety approved & BS EN/EN60335-1, BS EN/EN61558-1, BS EN/EN62368-1 (report); Design refer to EN62477-1				
	54V	UL/IEC62368-1, GB4943.1 safety approved & BS EN/EN60335-1, BS EN/EN61558-1, BS EN/EN62368-1 (report); Design refer to EN62477-1				

Safety Class	CLASS I
MTBF	MIL-HDBK-217F@25°C >300,000 h

Mechanical Specifications

Case Material	Metal (AL5052, SGCC)
Dimensions	99.00 x 97.00 x 30.00 mm
Weight	260g (Typ.)
Cooling Method	Free air convection

Electromagnetic Compatibility (EMC)

Emissions	CE	CISPR32/EN55032	CLASS B	
	RE	CISPR32/EN55032	CLASS B	
	Harmonic current	IEC/EN61000-3-2	CLASS A	
Immunity	ESD	IEC/EN61000-4-2	Contact ±6KV/Air ±8KV	perf. Criteria A
	RS	IEC/EN61000-4-3	10V/m	perf. Criteria A
	EFT	IEC/EN61000-4-4	±4KV	perf. Criteria A
	Surge	IEC/EN61000-4-5	line to line ±2KV/line to PE ±4KV	perf. Criteria A
	CS	IEC/EN61000-4-6	10 Vr.m.s	perf. Criteria A
	PFMF	IEC/EN61000-4-8	30A/m	perf. Criteria A
	Voltage dip, short interruption and voltage variation	IEC/EN61000-4-11	0%, 70%	perf. Criteria B

Note: If the EMC performance needed to be improved, please add EMC filter FC-L03Wx series (see wiring diagram 1). Details of specific indicators please refer to filter datasheet.

Product Characteristic Curve

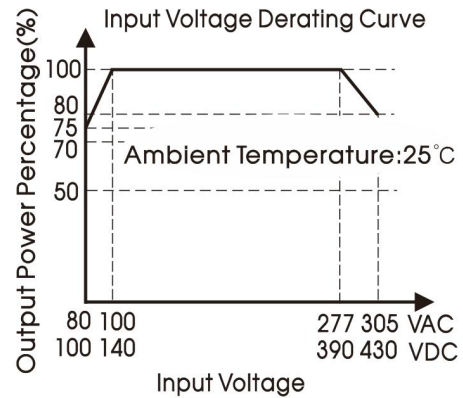
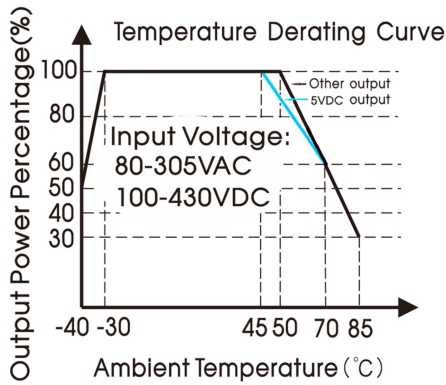

Note: 1. With an AC input voltage between 80-100VAC/277-305VAC and a DC input between 100-140VDC/390-430VDC the output power must be derated as per the temperature derating curves;

2. This product is suitable for applications using natural air cooling; for applications in closed environment please consult Mornsun FAE.

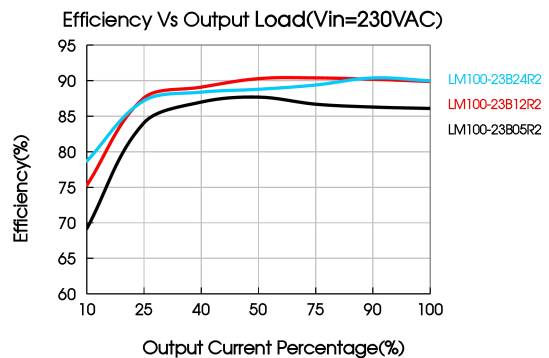
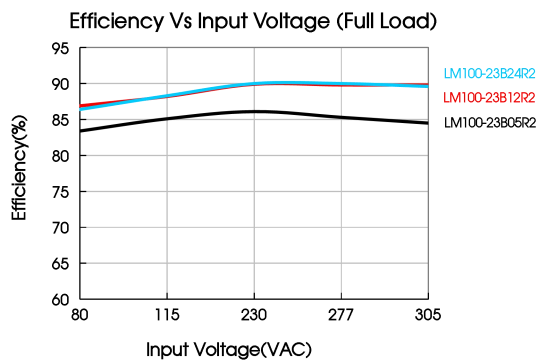

FC-L03Wx & LM100-23BxxR2 Wiring Diagram

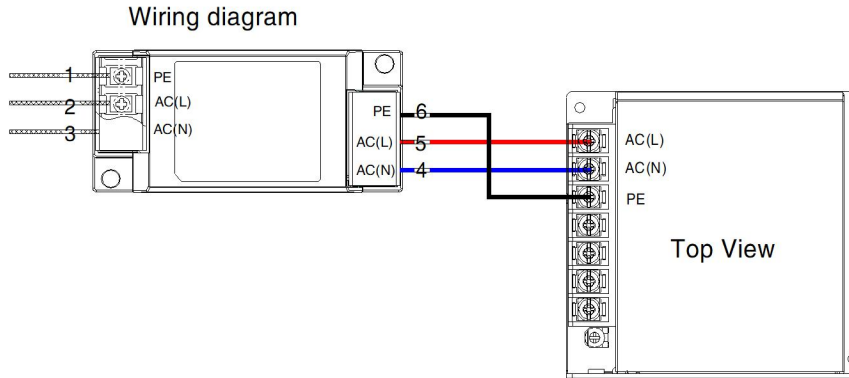
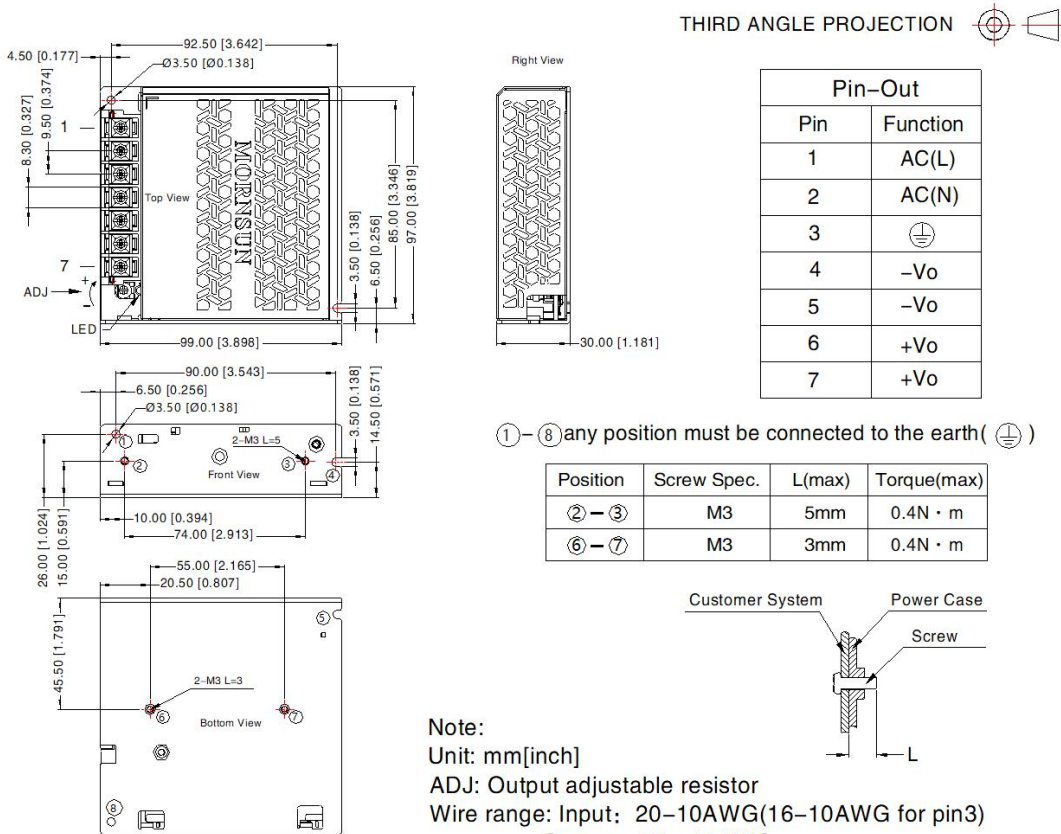

Fig. 1: EMC application circuit with higher requirement

Dimensions and Recommended Layout

LM100-23BxxR2(-Q, -QQ) Series



Note:

Unit: mm[inch]

ADJ: Output adjustable resistor

Wire range: Input: 20-10AWG(16-10AWG for pin3)

Output: 5V: 10AWG

12V, 15V: 14-10AWG

24V, 36V: 17-10AWG

48V, 54V: 20-10AWG

Connector tightening torque: M3.5, Max 0.8N·m

General tolerances: ± 1.00[± 0.039]

LM100-23BxxR2-C (-CQ, -CQQ) Series

THIRD ANGLE PROJECTION 

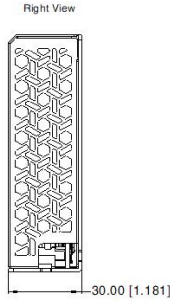
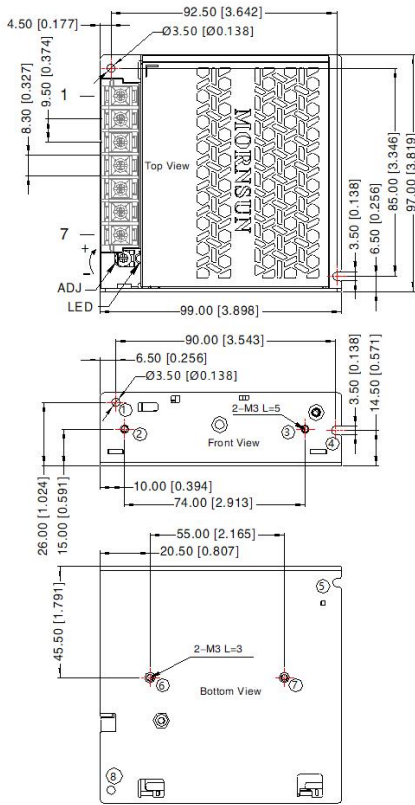

Pin-Out	
Pin	Function
1	AC(L)
2	AC(N)
3	⊕
4	-Vo
5	-Vo
6	+Vo
7	+Vo

①-⑧ any position must be connected to the earth (⊕)

Position	Screw Spec.	L(max)	Torque(max)
②-③	M3	5mm	0.4N·m
⑥-⑦	M3	3mm	0.4N·m

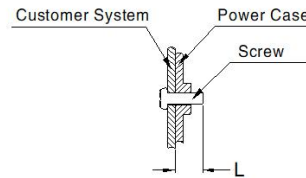

Note:

Unit: mm[inch]

ADJ: Output adjustable resistor

Wire range: Input: 20-10AWG(16-10AWG for pin3)

Output: 5V: 10AWG

12V, 15V: 14-10AWG

24V, 36V: 17-10AWG

48V, 54V: 20-10AWG

Connector tightening torque: M3.5, Max 0.8N·m

General tolerances: ± 1.00[± 0.039]

Note:

- For additional information on Product Packaging please refer to www.mornsun-power.com. Packaging bag number: 58220269;
- Unless otherwise specified, parameters in this datasheet were measured under the conditions of $T_a=25^{\circ}\text{C}$, humidity<75%RH with nominal input voltage and rated output load;
- The room temperature derating of $5^{\circ}\text{C}/1000\text{m}$ is needed for operating altitude greater than 2000m;
- All index testing methods in this datasheet are based on our company corporate standards;
- In order to improve the efficiency at high input voltage, there will be audible noise generated, but it does not affect product performance and reliability;
- We can provide product customization service, please contact our technicians directly for specific information;
- Products are related to laws and regulations: see "Features" and "EMC";
- The out case needs to be connected to the earth (⊕) of system when the terminal equipment in operating;
- The output voltage can be adjusted by the ADJ, clockwise to increase;
- Our products shall be classified according to ISO14001 and related environmental laws and regulations, and shall be handled by qualified units;
- The power supply is considered a component which will be installed into a terminal equipment. All EMC tests should be confirmed with the final equipment. Please consult our FAE for EMC test operation instructions.

Mornsun Guangzhou Science & Technology Co., Ltd.

Address: No. 5, Kehui St. 1, Kehui Development Center, Science Ave., Guangzhou Science City, Huangpu District, Guangzhou, P. R. China

Tel: 86-20-38601850

Fax: 86-20-38601272

E-mail: info@mornsun.cn

www.mornsun-power.com