

10W isolated DC-DC converter in DIP package
Ultra-wide input and regulated dual/single output

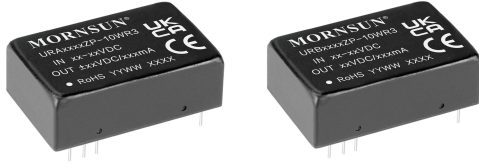

Patent Protection
 EN62368-1
 BS EN62368-1
 RoHS

FEATURES

- Ultra-wide 4:1 input voltage range
- High efficiency up to 88%
- No-load power consumption as low as 0.12W
- I/O isolation test voltage: 1.5k VDC
- Operating ambient temperature range: -40°C to +85°C
- Input under-voltage protection, output short-circuit, over-current and over-voltage protection
- Meet CISPR32/EN55032 CLASS A, without extra components
- Industry standard pin-out
- Meets EN50155 standards

URA_ZP-10WR3 & URB_ZP-10WR3 series are isolated 10W DC-DC converter products with an extremely wide voltage input range of 9-36VDC or 18-75VDC, input to output isolation voltage of 1500VDC, input under-voltage protection, output short-circuit, over-current and over-voltage protection. They meet CLASS A of CISPR32/EN55032 EMI standards without external components and they are widely used in applications such as industrial controls, electric power, instrumentation, communications and railway.

Selection Guide

Certification	Part No.	Input Voltage (VDC)		Output		Full Load Efficiency ^② (%) Min./Typ.	Capacitive Load ^③ (μF)Max.
		Nominal (Range)	Max. ^①	Voltage(VDC)	Current (mA) Max./Min.		
EN/BS EN	URA2405ZP-10WR3	24 (9-36)	40	±5	±1000/0	81/83	1000
	URA2412ZP-10WR3			±12	±416/0	85/87	470
	URA2415ZP-10WR3			±15	±333/0	85/87	330
	URB2403ZP-10WR3			3.3	2400/0	84/86	1200
	URB2405ZP-10WR3			5	2000/0	85/87	1000
	URB2412ZP-10WR3			12	833/0	85/87	470
	URB2415ZP-10WR3			15	667/0	85/87	330
	URB2424ZP-10WR3			24	416/0	86/88	100
	URA4805ZP-10WR3			48 (18-75)	80	±5	±1000/0
	URA4812ZP-10WR3	±12	±416/0			85/87	470
	URA4815ZP-10WR3	±15	±333/0			85/87	330
	URB4803ZP-10WR3	3.3	2400/0			83/85	1200
	URB4805ZP-10WR3	5	2000/0			84/86	1000
	URB4812ZP-10WR3	12	833/0			85/87	470
	URB4815ZP-10WR3	15	667/0			85/87	330
	URB4824ZP-10WR3	24	416/0			86/88	100

Notes: ① Exceeding the maximum input voltage may cause permanent damage;
 ② Efficiency is measured at nominal input voltage and rated output load;
 ③ The specified maximum capacitive load value for Vo1 and Vo2 output is identical;
 ④ We suggest to connect an external electrolytic capacitor if there is a spike voltage at the input, details please refer to application circuit.

Input Specifications

Item	Operating Conditions	Min.	Typ.	Max.	Unit
Input Current (full load / no-load)	24VDC nominal input series, nominal input voltage	3.3VDC single output	--	380/12	389/25
		5VDC single output	--	474/6	485/15
		others	--	502/5	515/12
	48VDC nominal input series, nominal input voltage	3.3VDC single output	--	192/5	197/20
		5VDC single output	--	240/6	245/15
		others	--	251/4	258/8
Reflected Ripple Current	24VDC nominal input series, nominal input voltage	--	40	--	mA
	48VDC nominal input series, nominal input voltage	--	30	--	

Surge Voltage (1sec. max.)	24VDC nominal input series	-0.7	--	50	VDC
	48VDC nominal input series	-0.7	--	100	
Start-up Voltage	24VDC nominal input series	--	--	9	
	48VDC nominal input series	--	--	18	
Under-voltage Protection	24VDC nominal input series	5.5	6.5	--	
	48VDC nominal input series	12	15.5	--	
Input Filter		Pi filter			
Hot Plug		Unavailable			
Ctrl *	Module on	Ctrl pin open or pulled high (3.5-12VDC)			
	Module off	Ctrl pin pulled low to GND (0-1.2VDC)			
	Input current when off	--	6	10	mA

Note: *The Ctrl pin voltage is referenced to input pin GND.

Output Specifications

Item	Operating Conditions		Min.	Typ.	Max.	Unit
Voltage Accuracy ^①	0%-100% load	3.3VDC/5VDC single output	--	± 0.5	± 2	%
		Others	--	± 1	± 3	
Linear Regulation	Input voltage variation from low to high at full load	Vo1	--	±0.2	±0.5	
		Vo2	--	±0.5	± 1	
Load Regulation ^②	5%-100% load	Vo1	--	±0.5	± 1	
		Vo2	--	±0.5	± 1.5	
Cross Regulation	Dual output, Vo1 load at 50%, Vo2 load at range of 25%-100%		--	--	± 5	
Transient Recovery Time			--	300	500	μs
Transient Response Deviation	25% load step change, nominal input voltage	3.3VDC/5VDC single output	--	± 5	± 8	%
		Others	--	± 3	± 5	
Temperature Coefficient	Full load		--	--	±0.03	%/°C
Ripple & Noise ^③	20MHz bandwidth		--	40	80	mVp-p
Over-voltage Protection	Input voltage range		110	--	160	%Vo
Over-current Protection	Input voltage range	3.3VDC/5VDC single output	110	160	230	%Io
		Others	110	140	190	
Short-circuit Protection	Input voltage range		Continuous, self-recovery			

Note: ① At 0% - 5% load, the Max. output voltage accuracy of ±5VDC output converter is ±5%, the Max. output voltage accuracy of 3.3VDC/5VDC output converter is ±3%;
 ② Load regulation for 0% - 100% load increases to ±5%;
 ③ Under 0% - 5% load conditions, ripple & noise does not exceed 5%Vo. The "parallel cable" method is used for ripple and noise test, please refer to *DC-DC Converter Application Notes* for specific information.

General Specifications

Item	Operating Conditions	Min.	Typ.	Max.	Unit
Isolation	Input-output Electric Strength Test for 1 minute with a leakage current of 1mA max.	1500	--	--	VDC
Insulation Resistance	Input-output resistance at 500VDC	1000	--	--	MΩ
Isolation Capacitance	Input-output capacitance at 100kHz/0.1V	--	2000	--	pF
Operating Temperature	See Fig. 1	-40	--	+85	°C
Storage Temperature		-55	--	+125	
Storage Humidity	Non-condensing	5	--	95	%RH
Pin Soldering Resistance Temperature	Soldering spot is 1.5mm away from case for 10 seconds	--	--	+300	°C
Vibration(EN62368)		10-150Hz, 5G, 0.75mm. along X, Y and Z			
Vibration(EN50155)		IEC/EN61373 - Category 1, Grade B			
Switching Frequency *	PWM mode	--	350	--	kHz
MTBF	MIL-HDBK-217F@25°C	1000	--	--	k hours

Note: *Switching frequency is measured at full load. The module reduces the switching frequency for light load (below 50%) efficiency improvement.

Mechanical Specifications

Case Material	Aluminum alloy
Dimensions	32.00 x 20.00 x 10.80mm
Weight	12.0g(Typ.)
Cooling Method	Free air convection

Electromagnetic Compatibility (EMC)

Emissions	CE	CISPR32/EN55032	CLASS A (without extra components)/ CLASS B (see Fig.3-② for recommended circuit)	
	RE	CISPR32/EN55032	CLASS A (without extra components)/ CLASS B (see Fig.3-② for recommended circuit)	
Immunity	ESD	IEC/EN61000-4-2	Contact $\pm 4kV$	perf. Criteria B
	RS	IEC/EN61000-4-3	10V/m	perf. Criteria A
	EFT	IEC/EN61000-4-4	$\pm 2kV$ (see Fig.3-① for recommended circuit)	perf. Criteria B
	Surge	IEC/EN61000-4-5	line to line $\pm 2kV$ (see Fig.3-① for recommended circuit)	perf. Criteria B
	CS	IEC/EN61000-4-6	10 Vr.m.s	perf. Criteria A
	Immunities of voltage dip, drop and short interruption	IEC/EN61000-4-29	0%, 70%	perf. Criteria B

Electromagnetic Compatibility (EMC) (EN50155)

EMI	CE	EN50121-3-2	150kHz-500kHz	99dBuV(see Fig.3-② for recommended circuit)	
	RE	EN50121-3-2	30MHz-230MHz	40dBuV/m at 10m(see Fig.3-② for recommended circuit)	
EMS	ESD	EN50121-3-2	Contact $\pm 6kV$ /Air $\pm 8kV$		perf. Criteria B
	RS	EN50121-3-2	20V/m		perf. Criteria A
	EFT	EN50121-3-2	$\pm 2kV$ 5/50ns 5kHz(see Fig.3-① for recommended circuit)		perf. Criteria A
	Surge	EN50121-3-2	line to line $\pm 1kV$ (42Ω , $0.5\mu F$) (see Fig.3-① for recommended circuit)		perf. Criteria A
	CS	EN50121-3-2	0.15MHz-80MHz	10 Vr.m.s	perf. Criteria A

Typical Characteristic Curves

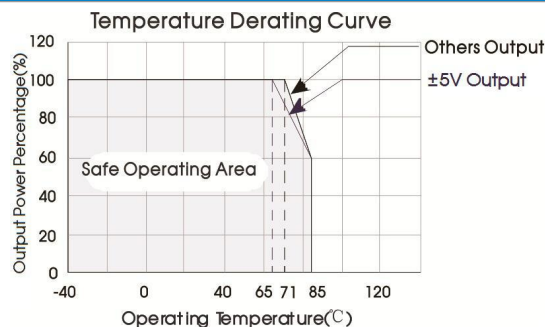
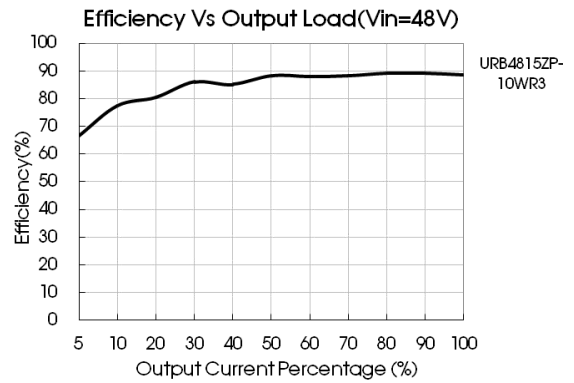
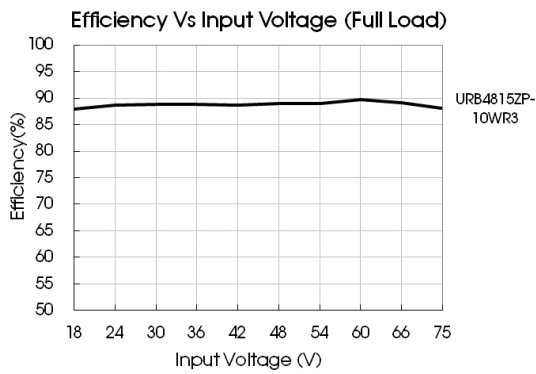
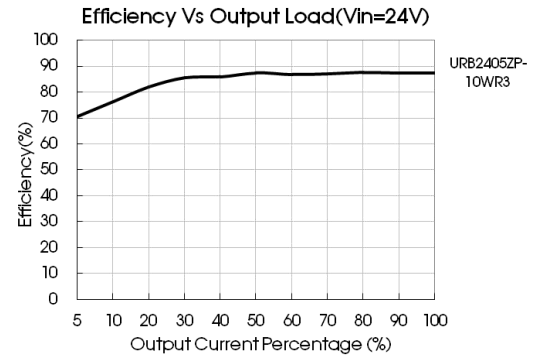
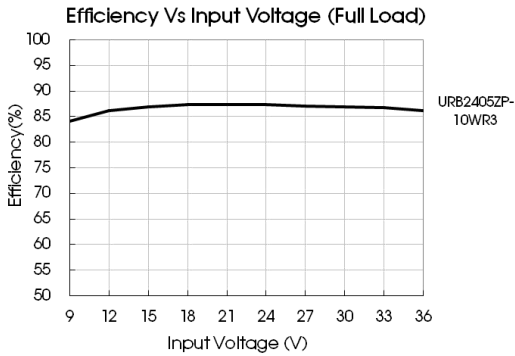
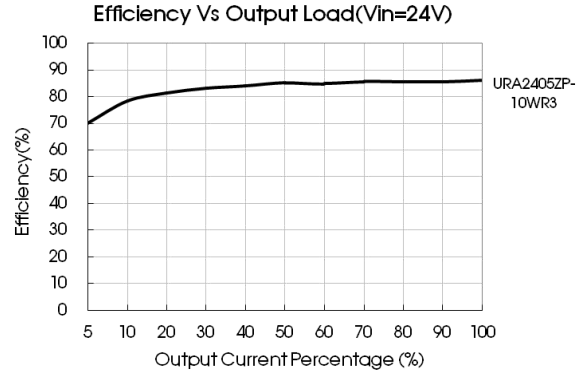
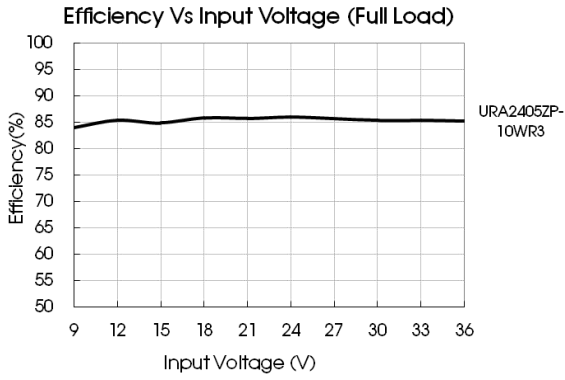

Fig. 1



Design Reference

1. Typical application

All DC-DC converters of this series are tested before delivery using the recommended circuit shown in Fig. 2.

Input and/or output ripple can be further reduced by appropriately increasing the input & output capacitor values C_{in} and C_{out} and/or by selecting capacitors with a low ESR (equivalent series resistance). Also make sure that the capacitance is not exceeding the max. capacitive load value of the product.

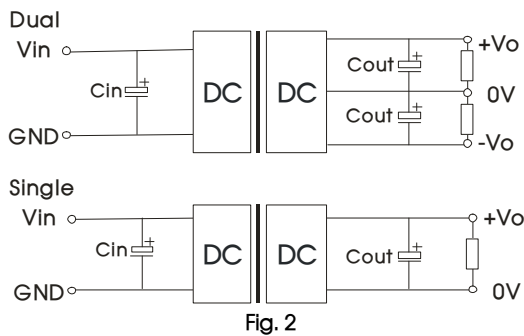

V_{in} (VDC)	V_{out} (VDC)	C_{in}	C_{out}
24	3/5/±5	100µF/50V	10µF/16V
	12/15/±12/±15		10µF/25V
	24		10µF/50V
48	3/5/±5	10µF - 47µF/100V	10µF/16V
	12/15/±12/±15		10µF/25V
	24		10µF/50V

2. EMC compliance circuit

Parameter description:

Model	Vin: 24VDC	Vin: 48VDC
FUSE	Select FUSE value according to actual input current	
C0, C4	330μF/50V	330μF/100V
C1, C2	10μF/50V	10μF/100V
LDM1	10μH	
LCM1	1.4-1.7mH (TN150P-RH12.7*12.7*7.9)	
C3	Refer to the Cout in Fig.2	
CY1, CY2	1nF/2kV	

3.3VDC/5VDC single output:

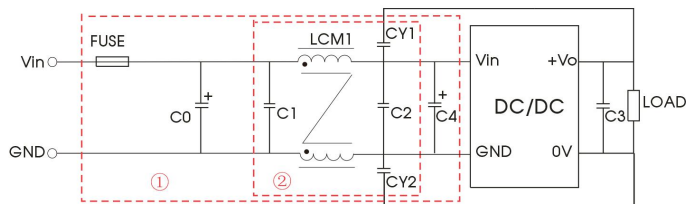

Others:

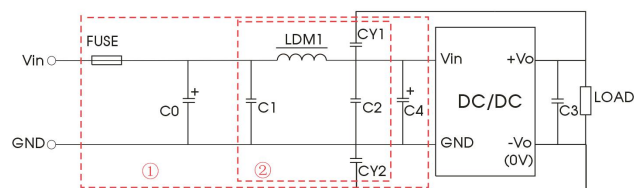
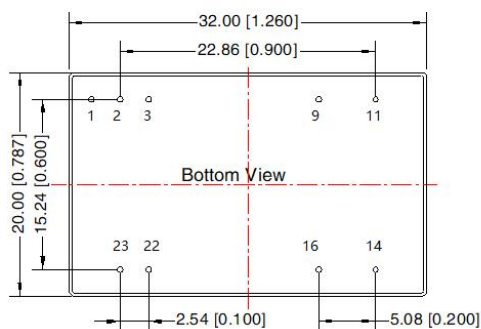
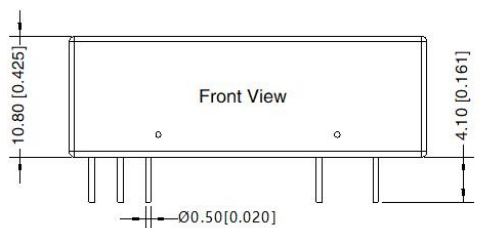

Fig. 3

Notes: For EMC tests we use Part ① in Fig. 3 for immunity and part ② for emissions test. Selecting based on needs.

- The products do not support parallel connection of their output
- For additional information please refer to DC-DC converter application notes on www.mornsun-power.com

Dimensions and Recommended Layout



Note:
Unit: mm[inch]
Pin diameter tolerances: $\pm 0.10[\pm 0.004]$
General tolerances: $\pm 0.50[\pm 0.020]$

THIRD ANGLE PROJECTION

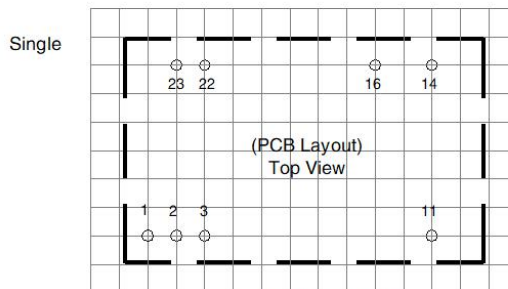
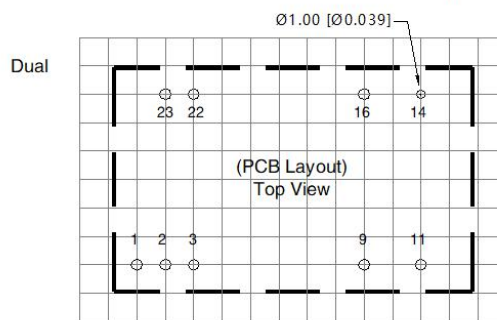

Note: Grid 2.54*2.54mm

Pin	Pin-Out	
	Single	Dual
1	Ctrl	Ctrl
2,3	GND	GND
9	No Pin	0V
11	NC	-Vo
14	+Vo	+Vo
16	0V	0V
22,23	Vin	Vin

NC: Pin to be isolated from circuit

Notes:

1. For additional information on Product Packaging please refer to www.mornsun-power.com. Packaging bag number: 58210008;
2. The maximum capacitive load offered were tested at input voltage range and full load;
3. Unless otherwise specified, parameters in this datasheet were measured under the conditions of $T_a=25^{\circ}\text{C}$, humidity<75%RH with nominal input voltage and rated output load;
4. All index testing methods in this datasheet are based on company corporate standards;
5. We can provide product customization service, please contact our technicians directly for specific information;
6. Products are related to laws and regulations: see "Features" and "EMC";
7. Our products shall be classified according to ISO14001 and related environmental laws and regulations, and shall be handled by qualified units.

Mornsun Guangzhou Science & Technology Co., Ltd.

Address: No. 5, Kehui St. 1, Kehui Development Center, Science Ave., Guangzhou Science City, Huangpu District, Guangzhou, P. R. China
Tel: 86-20-38601850 Fax: 86-20-38601272 E-mail: info@mornsun.cn www.mornsun-power.com