

**TV-4 rated.
2a 3A/5A power relays**

LA RELAYS (ALA)



RoHS compliant

FEATURES

- 1. 2 Form A slim type**
24(L) × 12(W) × 25(H) mm
.945(L)×.472(W)×.984(H) inch
- 2. 3A type and 5A TV type**
3A type: Contact reliability and break performance best suited for protecting and switching speakers.
5A TV type: Tough against inrush current and optimal for turning on and off the power supply. Rated TV-4 (UL, CSA).
- 3. High insulation resistance**
 - Creepage distance and clearances between contact and coil: Min. 6 mm .236 inch (In compliance with IEC65)
 - Surge withstand voltage between contact and coil: 10,000 V

- 4. High noise immunity realized by the card separation structure between contact and coil**
- 5. Conforms to the various safety standards**
 - UL, CSA, VDE, TÜV, SEMKO approved

TYPICAL APPLICATIONS

- Audio devices
- Monitor
- Automatic vending machine

ORDERING INFORMATION

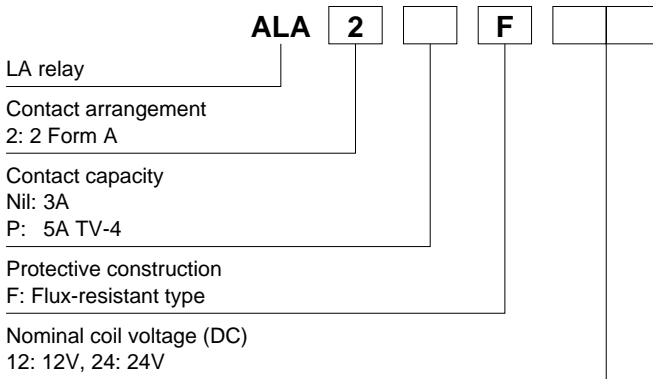

Note: Certified by UL, CSA, VDE, TÜV, SEMKO and TV-4

TYPES

| Contact arrangement | Coil voltage | Part No. | |
|---------------------|--------------|----------|-------------------|
| | | 3A type | 5A TV type (TV-4) |
| 2 Form A | 12V DC | ALA2F12 | ALA2PF12 |
| | 24V DC | ALA2F24 | ALA2PF24 |

Standard packing Carton: 100 pcs. Case: 500 pcs.

Note: 4.5V, 5V, 9V and 18V DC types are also available. Please consult us for details.

RATING

1. Coil data

| Nominal coil voltage | Pick-up voltage (at 20°C 68°F) | Drop-out voltage (at 20°C 68°F) | Nominal operating current [±10%] (at 20°C 68°F) | Coil resistance [±10%] (at 20°C 68°F) | Nominal operating power | Max. applied voltage (at 20°C 68°F) |
|----------------------|---|--|---|---------------------------------------|-------------------------|-------------------------------------|
| 12V DC | 75%V or less of nominal voltage (Initial) | 5%V or more of nominal voltage (Initial) | 44.2mA | 272Ω | 530mW | 15.6V DC |
| 24V DC | | | 22.1mA | 1,087Ω | | 31.2V DC |

2. Specifications

| Characteristics | Item | Specifications | |
|--|--|---|--|
| | | 3A type | 5A TV type (TV-4) |
| Contact | Arrangement | 2 Form A | |
| | Contact resistance (Initial) | Max. 50 mΩ (By voltage drop 6V DC 1A) | Max. 100 mΩ (By voltage drop 6V DC 1A) |
| | Contact material | Gold-clad, AgNi type | AgSnO ₂ type |
| Rating | Nominal switching capacity (resistive load) | 3A 125V AC | 5A 277V AC |
| | Max. switching power (resistive load) | 625VA | 1,385VA |
| | Max. switching voltage | 125V AC | 277V AC |
| | Max. switching current | 5A (AC) | |
| | Min. switching capacity*1 | 100mA 5V DC | |
| Electrical characteristics | Insulation resistance (Initial) | Min. 1,000MΩ (at 500V DC) Measurement at same location as "Breakdown voltage" section. | |
| | Breakdown voltage (Initial) | Between contact sets | 1,000 Vrms for 1 min. (Detection current: 10 mA) |
| | | Between open contacts | 1,000 Vrms for 1 min. (Detection current: 10 mA) |
| | | Between contact and coil | 4,000 Vrms for 1 min. (Detection current: 10 mA) |
| | Temperature rise (coil) | Max. 45°C 113°F (with nominal coil voltage and at 3 A contact carrying current, at 70°C 158°F) | Max. 45°C 113°F (with nominal coil voltage and at 5 A contact carrying current, at 70°C 158°F) |
| | Surge breakdown voltage*2 (Between contact and coil) (Initial) | 10,000 V | |
| | Operate time (at nominal voltage) (at 20°C 68°F) | Max. 15 ms (excluding contact bounce time.) | |
| Release time (at nominal voltage) (at 20°C 68°F) | Max. 15 ms (excluding contact bounce time) (With diode) | | |
| Mechanical characteristics | Shock resistance | Functional | 200 m/s ² (Half-wave pulse of sine wave: 11 ms; detection time: 10μs.) |
| | | Destructive | 1,000 m/s ² (Half-wave pulse of sine wave: 6 ms.) |
| | Vibration resistance | Functional | 10 to 55 Hz at double amplitude of 1.5 mm (Detection time: 10μs.) |
| | | Destructive | 10 to 55 Hz at double amplitude of 1.5 mm |
| Expected life | Mechanical | Min. 10 ⁶ (at 180 times/min.) | |
| | Electrical (at 20 times/min.) | Min. 5×10 ⁴ (ON: OFF=1.5s: 1.5s) (at nominal switching capacity) | |
| Conditions | Conditions for operation, transport and storage*3 | Ambient temperature: -40°C to +70°C -40°F to +158°F, Humidity: 5 to 85% R.H. (Not freezing and condensing at low temperature), Air pressure: 86 to 106kPa | |
| | Max. operating speed | 20 times/min. (at nominal switching capacity) | |
| Unit weight | | Approx. 13 g .46 oz | |

Notes: *1. This value can change due to the switching frequency, environmental conditions, and desired reliability level, therefore it is recommended to check this with the actual load.

*2. Wave is standard shock voltage of ±1.2×50μs according to JEC-212-1981

*3. The upper limit of the ambient temperature is the maximum temperature that can satisfy the coil temperature rise value. Refer to Usage, transport and storage conditions in NOTES.

REFERENCE DATA

1. Max. switching power (AC resistive load)

2-(1). Life curve (250 V AC resistive load)

2-(2). Life curve (125 V AC resistive load)

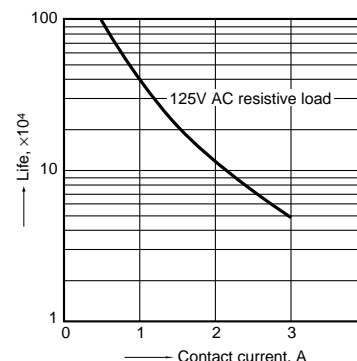
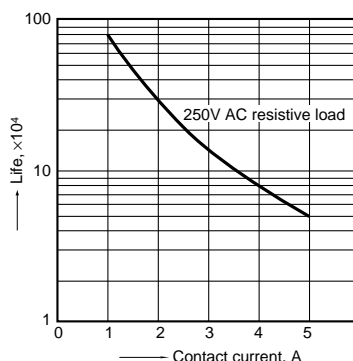
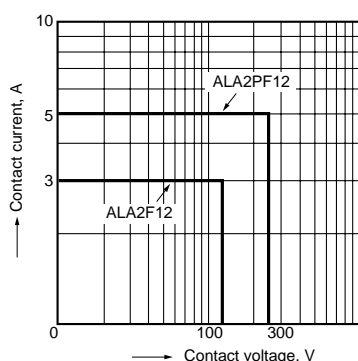

LA (ALA)

3-(1). Coil temperature rise

Sample: ALA2F12, 6 pcs.
Measured portion: coil inside
Contact current: 0 A, 3A

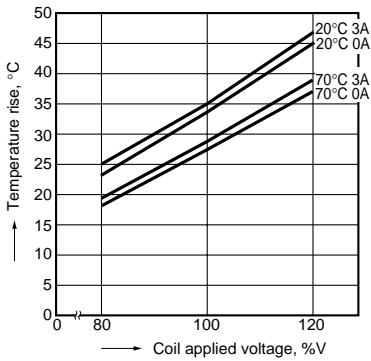

3-(2). Coil temperature rise

Sample: ALA2PF12, 6 pcs.
Measured portion: coil inside
Contact current: 0 A, 5A

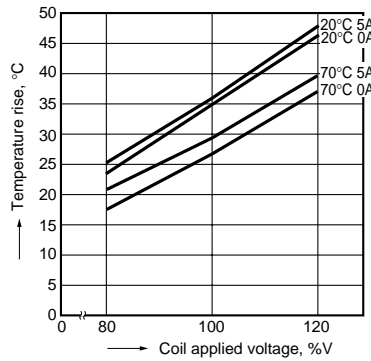

4. Ambient temperature characteristics and coil applied voltage

Contact current: ALA2F=3A
ALA2PF=5A

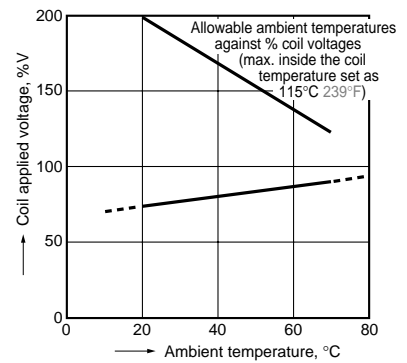

5-(1). Electrical life test

(3 A 125 V AC, resistive load)

Sample: ALA2F12, 6 pcs.
Operation frequency: 20 times/min.
(ON/OFF = 1.5s: 1.5s)
Ambient temperature: 20°C 68°F

Circuit:

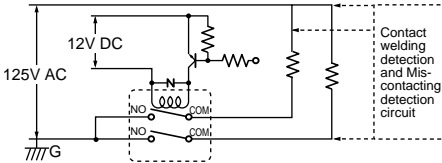

Change of pick-up and drop-out voltage

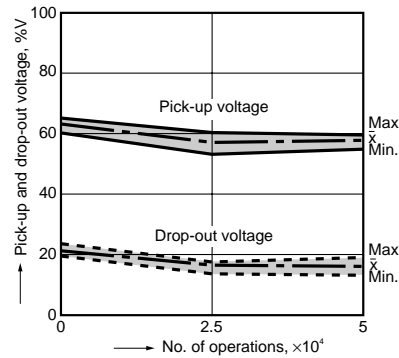

Change of contact resistance

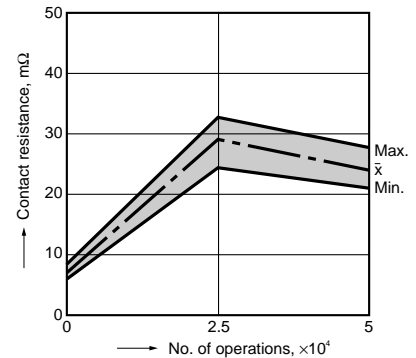

5-(2). Electrical life test

(5 A 250 V AC, resistive load)

Sample: ALA2PF12, 6 pcs.
Operation frequency: 20 times/min.
(ON/OFF = 1.5s: 1.5s)
Ambient temperature: 20°C 68°F

Circuit:

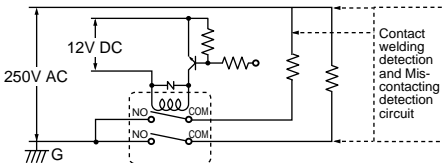

Change of pick-up and drop-out voltage

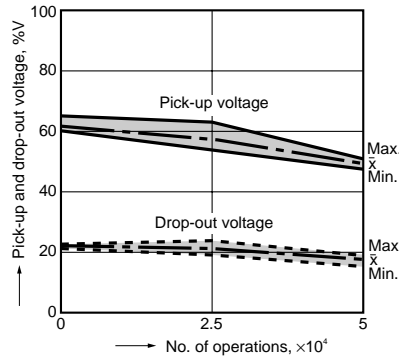

Change of contact resistance

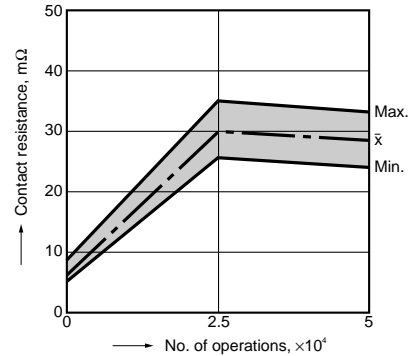

5-(3). Electrical life test

(UL lamp load test TV-4)

Tested sample: ALA2PF12, 6 pcs.

- Overload test
Load: 6.0 A 120 V AC (60 Hz),
Inrush: 91 A
Operation frequency: 10 times/min
(ON: OFF = 1 s: 5 s)
No. of operations: 50 ope.
- Endurance test
Load: 4A 120 V AC (60 Hz),
Inrush: 65 A
Operation frequency: 10 times/min
(ON: OFF = 1 s: 5 s)
No. of operations: 25,000 ope.

Change of pick-up and drop-out voltage

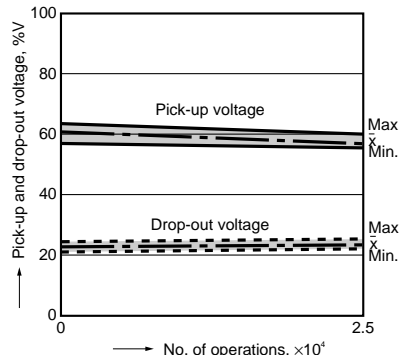

Change of contact resistance

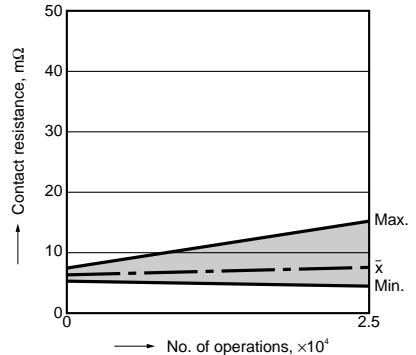

DIMENSIONS (mm inch)

The CAD data of the products with a **CAD Data** mark can be downloaded from: <http://industrial.panasonic.com/ac/e/>

CAD Data



External dimensions

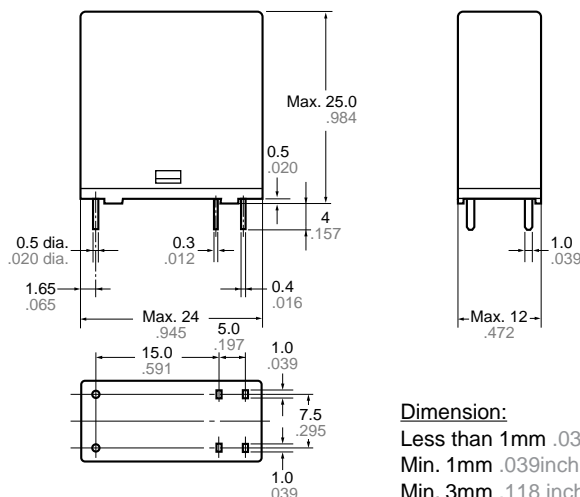

PC board pattern (Bottom view)

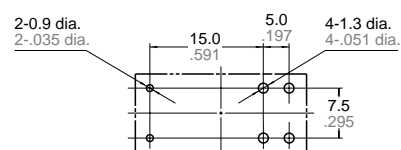

Tolerance : $\pm 0.1 \pm 0.004$

Schematic (Bottom view)



Dimension:

Less than 1mm .039inch:

Min. 1mm .039inch less than 3mm .118 inch:

Min. 3mm .118 inch:

General tolerance

$\pm 0.1 \pm 0.004$

$\pm 0.2 \pm 0.008$

$\pm 0.3 \pm 0.012$

SAFETY STANDARDS

| Item | UL/C-UL (Recognized) | | CSA (Certified) | | VDE (Certified) | | TV rating (UL/CSA) | | TÜV (Certified) | | SEMKO (Certified) | |
|---------------|----------------------|--------------------------------------|-----------------|--------------------------------------|-----------------|--|--------------------------------|--------|----------------------|--|-------------------|-------------------------|
| | File No. | Contact rating | File No. | Contact rating | File No. | Contact rating | File No. | Rating | File No. | Rating | File No. | Contact rating |
| Standard | E43149 | 3A 125V AC 3A 30V DC 5A 50V DC | LR26550 etc. | 3A 125V AC 3A 30V DC 5A 50V DC | 40012000 | 3A 125V AC ($\cos\phi=1.0$) 3A 30V DC (0ms) | — | — | B 11 05 13461 298 | 3A 125V AC ($\cos\phi=1.0$) 3A 30V DC (0ms) | 817139 | 3A 125V AC 3A 30V DC |
| High capacity | E43149 | 5A 277V AC 5A 30V DC | LR26550 etc. | 5A 277V AC 5A 30V DC | 40012000 | 5A 250V AC ($\cos\phi=1.0$) 5A 30V DC (0ms) | UL E43149 CSA LR26550 | TV-4 | B 11 05 13461 298 | 5A 250V AC ($\cos\phi=1.0$) 5A 30V DC (0ms) | 817139 | 4/65A 250V AC |

For Cautions for Use.

Mouser Electronics

Authorized Distributor

Click to View Pricing, Inventory, Delivery & Lifecycle Information:

Panasonic:

[ALA2F09](#) [ALA2F12](#) [ALA2F18](#) [ALA2F4H](#) [ALA2PF05](#) [ALA2PF09](#) [ALA2F24](#) [ALA2PF12](#) [ALA2F05](#) [ALA2PF18](#)
[ALA2PF24](#) [ALA2PF4H](#) [ALA2PFB06](#)