

| DIM. | TOL |
|-----------|------|
| L≤10 | ±0.2 |
| 10<L≤30 | ±0.3 |
| 30<L≤50 | ±0.5 |
| 50<L≤100 | ±0.7 |
| 100<L≤250 | ±1.2 |
| ABOVE 250 | ±1.5 |

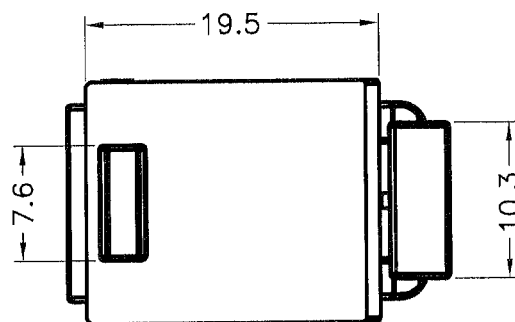

| REVISIONS | | | |
|-----------|-------------|------|----|
| REV | DESCRIPTION | DATE | BY |
| | | | |
| | | | |

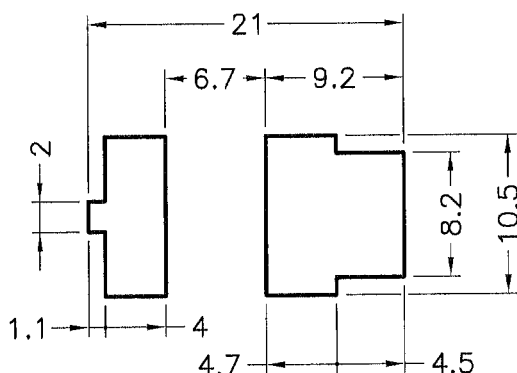
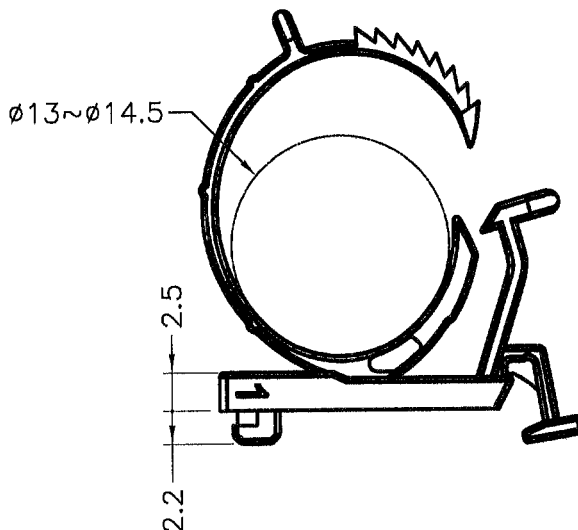
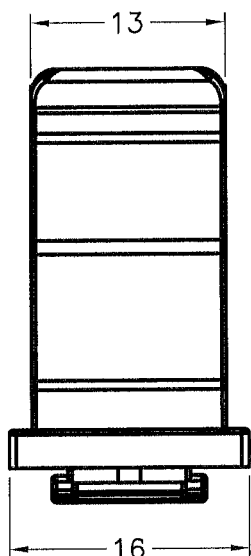

MOUNTING HOLE

NOTE: All measurement does not include gate which raises under 0.3mm.

KANG YANG
 康揚企業股份有限公司
 2021-04-13
 工程部
 R&D

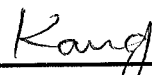
| | | | | |
|--|-------|--------------------------------------|------------------|---|
|  康揚企業股份有限公司 KANG YANG HARDWARE ENTERPRISE CO., LTD. 康揚塑膠(東莞)有限公司 KANG YANG PLASTIC(DONG GUAN) CO., LTD. 康哲電腦配件(吳江)有限公司 KANG CHE COMPUTER COMPONENTS(WUJIANG) CO., LTD. | | TITLE | WIRE MOUNT | SPEC. DWG. |
| | | MATERIAL | NYLON 66 UL94V-2 | DATE |
| PART NUMBER | | HARDNESS | DRAWN | SAI |
| DRAWING NUMBER | | COLOR | CHECK |  |
| SIZE | SCALE | UNLESS OTHERWISE SPECIFIED TOLERANCE | APPROVED |  |
| A4 | 2:1 | SEE ABOVE | | |