

Silicon NPN Power Transistors

2SC2921

DESCRIPTION

- With MT-200 package
- Complement to type 2SA1215

APPLICATIONS

- Audio and general purpose

PINNING(see Fig.2)

PIN	DESCRIPTION
1	Base
2	Collector;connected to mounting base
3	Emitter

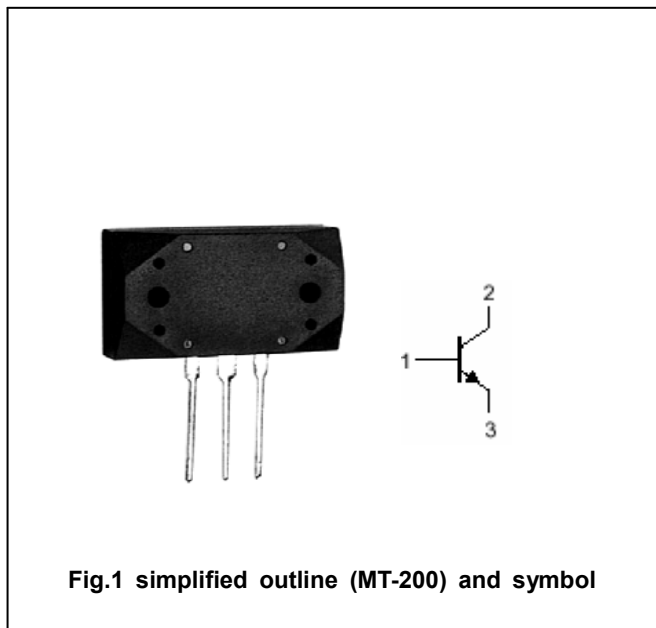

Absolute maximum ratings(Ta=25°C)

SYMBOL	PARAMETER	CONDITIONS	VALUE	UNIT
V _{CBO}	Collector-base voltage	Open emitter	160	V
V _{CEO}	Collector-emitter voltage	Open base	160	V
V _{EBO}	Emitter-base voltage	Open collector	5	V
I _C	Collector current		15	A
I _B	Base current		4	A
P _C	Collector power dissipation	T _C =25°C	150	W
T _j	Junction temperature		150	°C
T _{stg}	Storage temperature		-55~150	°C

Silicon NPN Power Transistors

2SC2921

CHARACTERISTICS

T_j=25 °C unless otherwise specified

SYMBOL	PARAMETER	CONDITIONS	MIN	TYP.	MAX	UNIT
V _{(BR)CEO}	Collector-emitter breakdown voltage	I _C =25mA ; I _B =0	160			V
V _{CEsat}	Collector-emitter saturation voltage	I _C =5A ; I _B =0.5A			2.0	V
I _{CBO}	Collector cut-off current	V _{CB} =160V; I _E =0			100	μA
I _{EBO}	Emitter cut-off current	V _{EB} =5V; I _C =0			100	μA
h _{FE}	DC current gain	I _C =5A ; V _{CE} =4V	50			
C _{ob}	Output capacitance	I _E =0 ; V _{CB} =10V;f=1MHz		200		pF
f _T	Transition frequency	I _E =-2A ; V _{CE} =12V		60		MHz

Switching times

t _{on}	Turn-on time	I _C =5A;R _L =12Ω I _{B1} =-I _{B2} =0.5A V _{CC} =60V		0.20		μs
t _s	Storage time			1.50		μs
t _f	Fall time			0.35		μs

◆ h_{FE} classifications

O	P	Y
50-100	70-140	90-180

Silicon NPN Power Transistors

2SC2921

PACKAGE OUTLINE

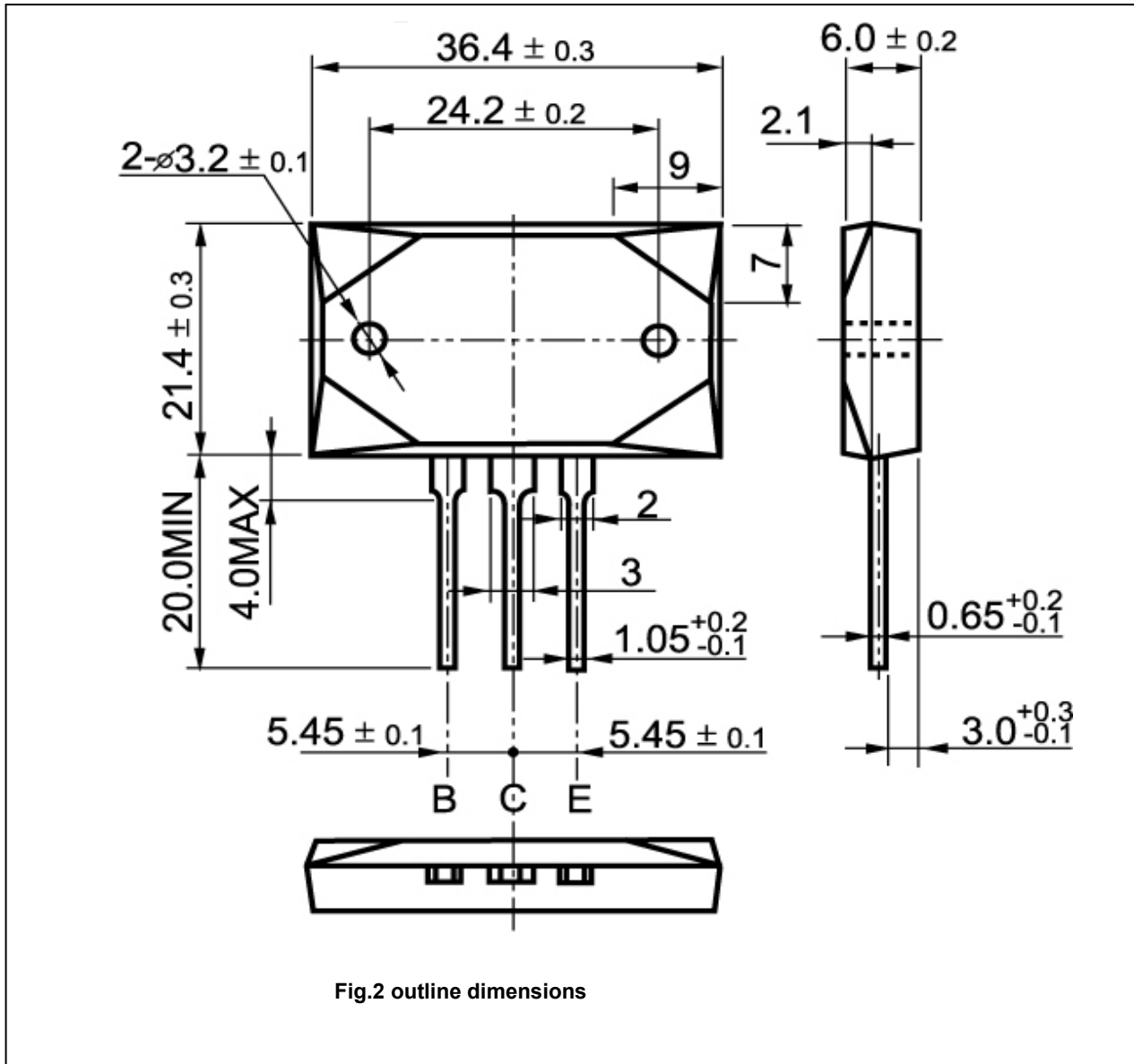

Silicon NPN Power Transistors

2SC2921

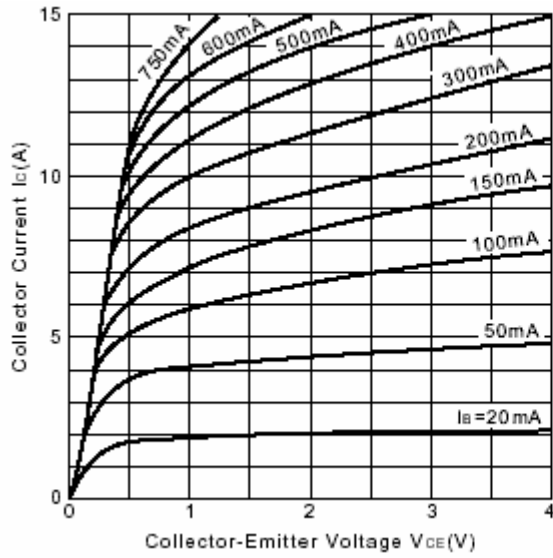

Fig.3 Static Characteristic

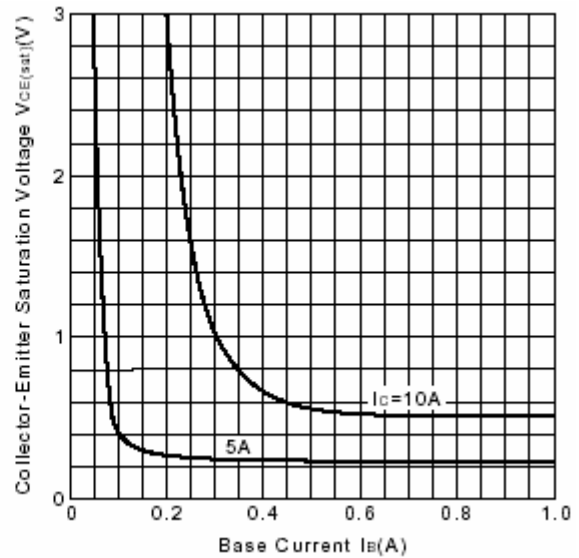

Fig.4 $V_{CE(sat)}-I_B$

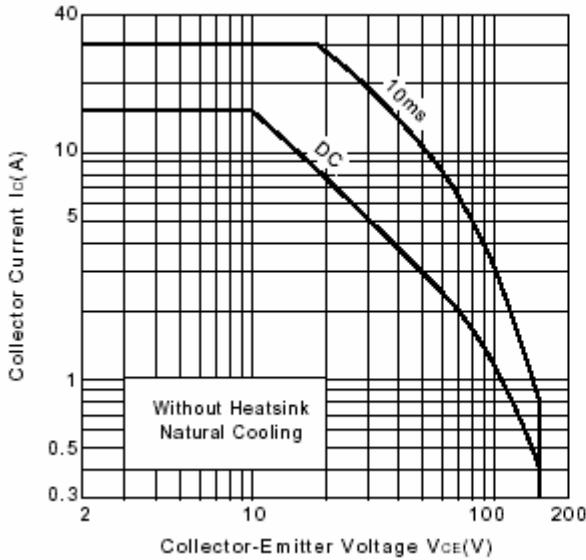

Fig.5 Safe Operating Area

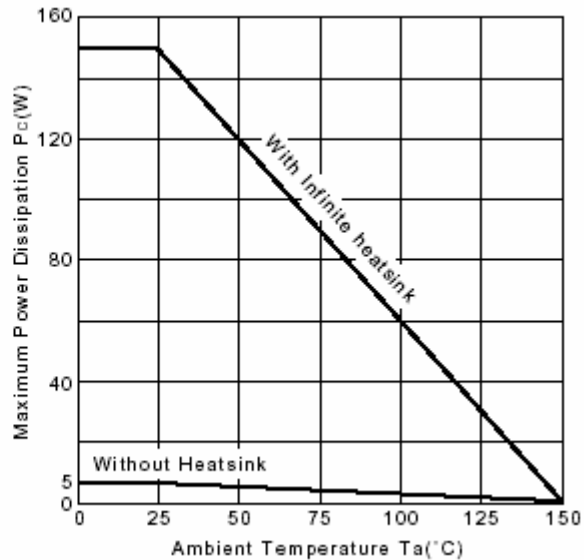

Fig.6 Power Derating

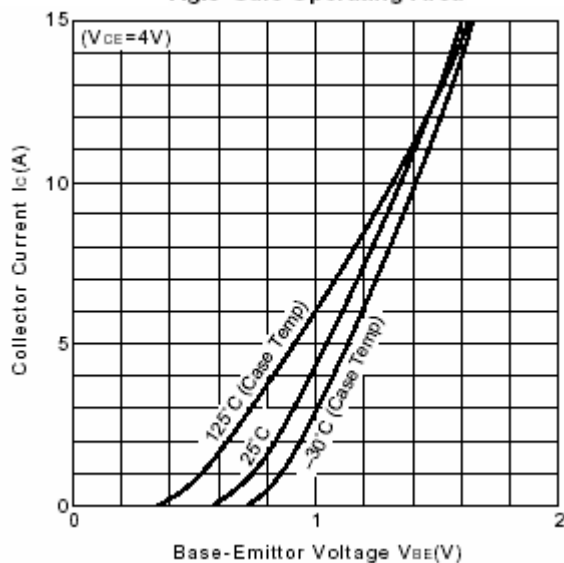

Fig.7 I_C-V_{BE}

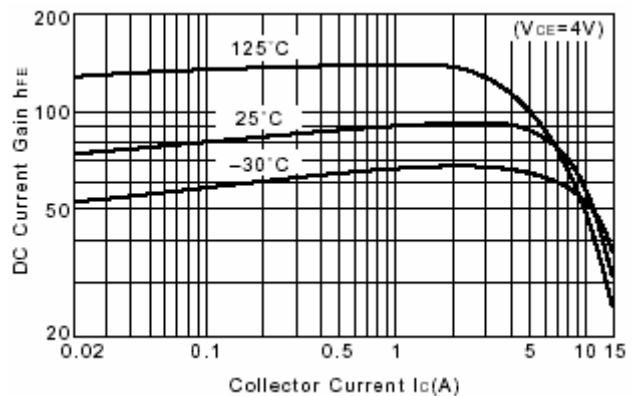

Fig.8 DC current Gain