

Silicon NPN Power Transistors

2SC4742

**DESCRIPTION**

- With TO-3PN package
- Built-in damper diode
- High breakdown voltage

**APPLICATIONS**

- Character display horizontal deflection output applications

**PINNING**

PIN	DESCRIPTION
1	Base
2	Collector;connected to mounting base
3	Emitter

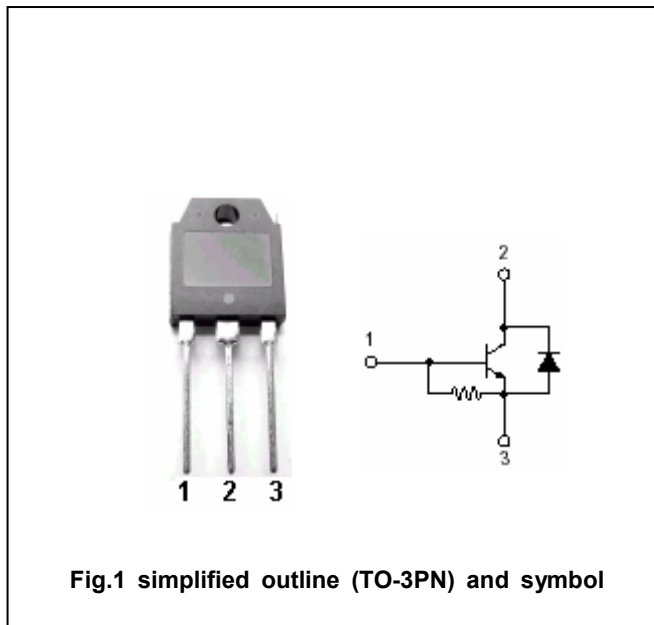

Fig.1 simplified outline (TO-3PN) and symbol

**Absolute maximum ratings(Ta=□)**

SYMBOL	PARAMETER	CONDITIONS	VALUE	UNIT
V <sub>CEO</sub>	Collector-emitter voltage	Open base	1500	V
V <sub>EBO</sub>	Emitter-base voltage	Open collector	6	V
I <sub>C</sub>	Collector current		6	A
I <sub>CM</sub>	Collector current-peak		7	A
I <sub>C(surge)</sub>	Collector current-surge		16	A
I <sub>o</sub>	C to E diode forward current		7	A
P <sub>C</sub>	Collector power dissipation	T <sub>C</sub> =25□	50	W
T <sub>j</sub>	Junction temperature		150	□
T <sub>stg</sub>	Storage temperature		-55~150	□

## Silicon NPN Power Transistors

## 2SC4742

## CHARACTERISTICS

T<sub>j</sub>=25°C unless otherwise specified

SYMBOL	PARAMETER	CONDITIONS	MIN	TYP.	MAX	UNIT
V <sub>(BR)EBO</sub>	Emitter-base breakdown voltage	I <sub>E</sub> =400mA ; I <sub>C</sub> =0	6			V
I <sub>CES</sub>	Collector cut-off current	V <sub>CE</sub> =1500V; R <sub>BE</sub> =0			0.5	mA
h <sub>FE</sub>	DC current gain	I <sub>C</sub> =1A ; V <sub>CE</sub> =5V			25	
V <sub>CE(sat)</sub>	Collector-emitter saturation voltage	I <sub>C</sub> =5A ; I <sub>B</sub> =1.25A			2.0	V
V <sub>BE(sat)</sub>	Base-emitter saturation voltage	I <sub>C</sub> =5A ; I <sub>B</sub> =1.25A			1.5	V
V <sub>ECF</sub>	Diode forward voltage	I <sub>F</sub> =6A			2.0	V
t <sub>f</sub>	Fall time	I <sub>CP</sub> =5A; I <sub>B1</sub> =1A; I <sub>B2</sub> =-2A			0.4	μs

Silicon NPN Power Transistors

2SC4742

PACKAGE OUTLINE

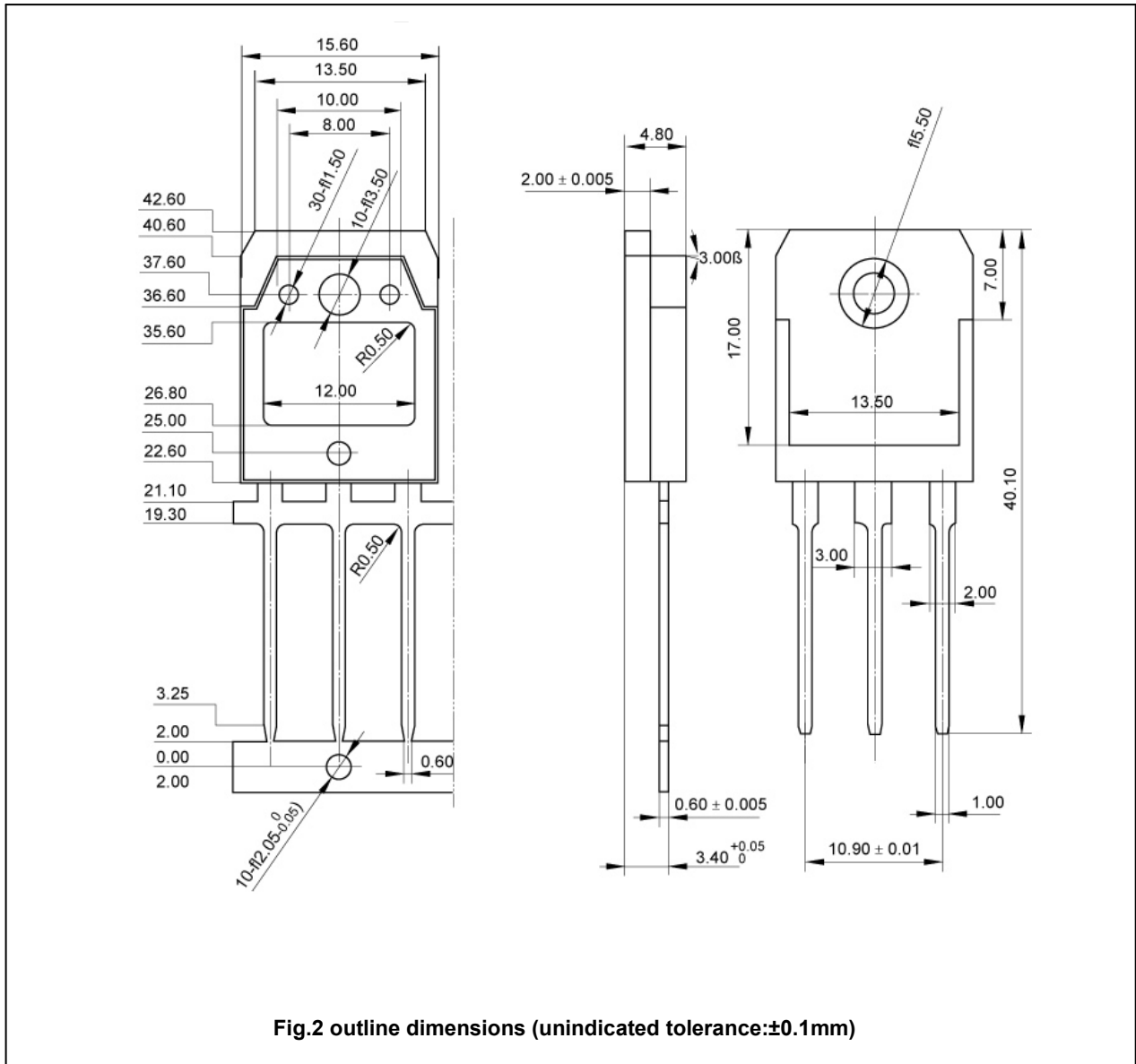

Silicon NPN Power Transistors

2SC4742

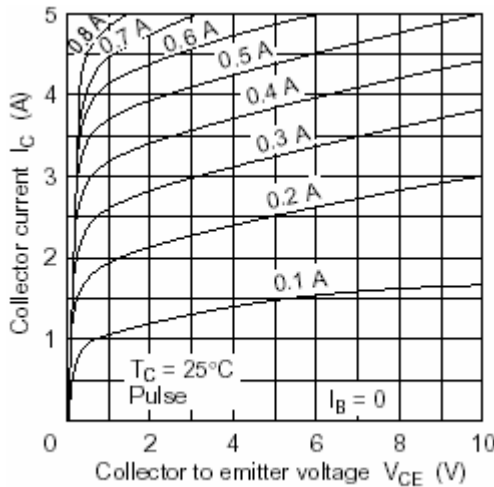

Fig.3 Static Characteristic

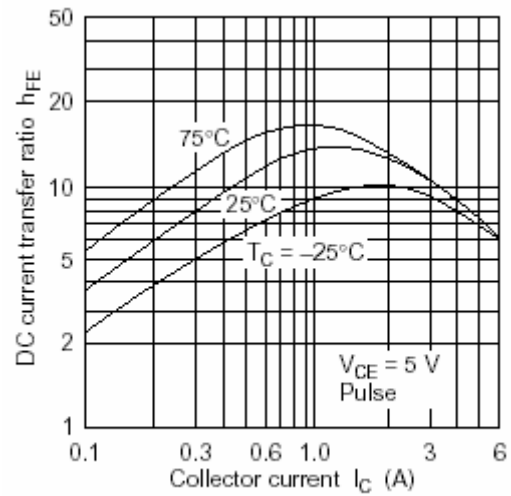

Fig.4 DC current Gain

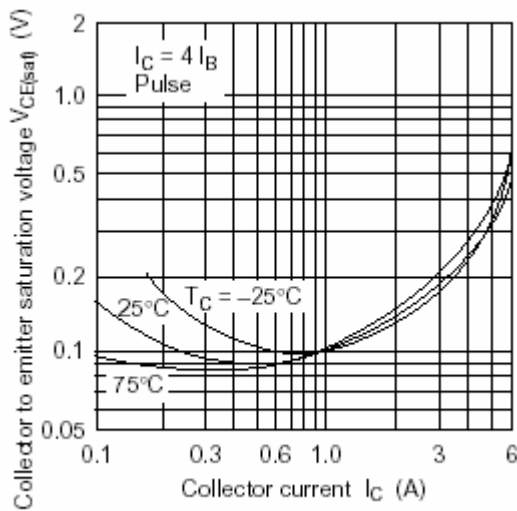

Fig.5 Collector-Emitter Saturation Voltage

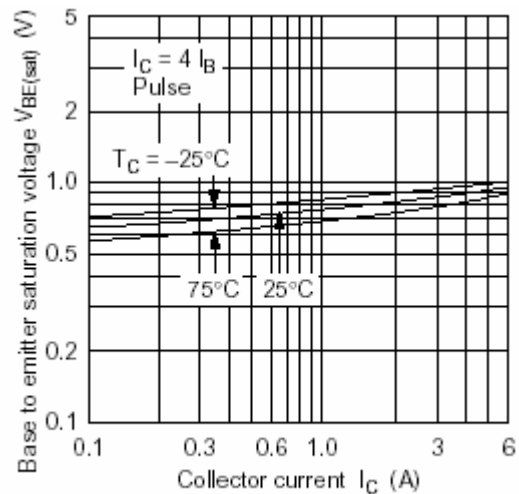

Fig.6 Base-Emitter Saturation Voltage

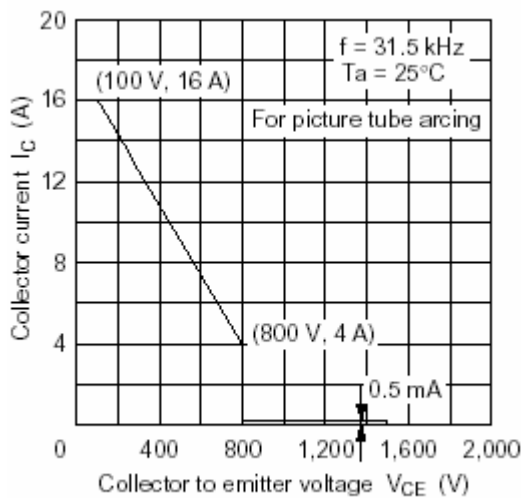

Fig.7 Safe Operating Area