

Power MOSFET

PRODUCT SUMMARY	
V_{DS} (V)	100
$R_{DS(on)}$ (Ω)	$V_{GS} = 10\text{ V}$ 0.27
Q_g (Max.) (nC)	16
Q_{gs} (nC)	4.4
Q_{gd} (nC)	7.7
Configuration	Single

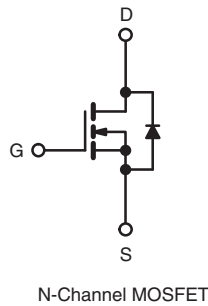
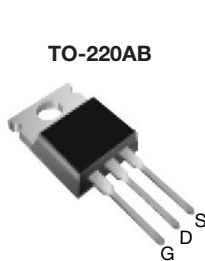

FEATURES

- Dynamic dV/dt Rating
- Repetitive Avalanche Rated
- 175 °C Operating Temperature
- Fast Switching
- Ease of Paralleling
- Simple Drive Requirements
- Compliant to RoHS Directive 2002/95/EC



Available
RoHS*
COMPLIANT

DESCRIPTION

Third generation Power MOSFETs from Vishay provide the designer with the best combination of fast switching, ruggedized device design, low on-resistance and cost-effectiveness.

The TO-220AB package is universally preferred for all commercial-industrial applications at power dissipation levels to approximately 50 W. The low thermal resistance and low package cost of the TO-220AB contribute to its wide acceptance throughout the industry.

ORDERING INFORMATION	
Package	TO-220AB
Lead (Pb)-free	IRF520PbF
	SiHF520-E3
SnPb	IRF520
	SiHF520



ABSOLUTE MAXIMUM RATINGS ($T_C = 25\text{ }^\circ\text{C}$, unless otherwise noted)					
PARAMETER		SYMBOL	LIMIT	UNIT	
Drain-Source Voltage		V_{DS}	100	V	
Gate-Source Voltage		V_{GS}	± 20		
Continuous Drain Current	V_{GS} at 10 V	I_D	$T_C = 25\text{ }^\circ\text{C}$	9.2	A
			$T_C = 100\text{ }^\circ\text{C}$		
Pulsed Drain Current ^a		I_{DM}	37		
Linear Derating Factor			0.40	W/ $^\circ\text{C}$	
Single Pulse Avalanche Energy ^b		E_{AS}	200	mJ	
Repetitive Avalanche Current ^a		I_{AR}	9.2	A	
Repetitive Avalanche Energy ^a		E_{AR}	6.0	mJ	
Maximum Power Dissipation	$T_C = 25\text{ }^\circ\text{C}$	P_D	60	W	
Peak Diode Recovery dV/dt^c		dV/dt	5.5	V/ns	
Operating Junction and Storage Temperature Range		T_J, T_{stg}	- 55 to + 175	$^\circ\text{C}$	
Soldering Recommendations (Peak Temperature)	for 10 s		300 ^d		
Mounting Torque	6-32 or M3 screw		10	lbf · in	
			1.1	N · m	

Notes

- Repetitive rating; pulse width limited by maximum junction temperature (see fig. 11).
- $V_{DD} = 25\text{ V}$, starting $T_J = 25\text{ }^\circ\text{C}$, $L = 3.5\text{ mH}$, $R_g = 25\text{ }\Omega$, $I_{AS} = 9.2\text{ A}$ (see fig. 12).
- $I_{SD} \leq 9.2\text{ A}$, $dI/dt \leq 110\text{ A}/\mu\text{s}$, $V_{DD} \leq V_{DS}$, $T_J \leq 175\text{ }^\circ\text{C}$.
- 1.6 mm from case.

* Pb containing terminations are not RoHS compliant, exemptions may apply

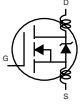
THERMAL RESISTANCE RATINGS				
PARAMETER	SYMBOL	TYP.	MAX.	UNIT
Maximum Junction-to-Ambient	R_{thJA}	-	62	°C/W
Case-to-Sink, Flat, Greased Surface	R_{thCS}	0.50	-	
Maximum Junction-to-Case (Drain)	R_{thJC}	-	2.5	

SPECIFICATIONS ($T_J = 25\text{ }^\circ\text{C}$, unless otherwise noted)						
PARAMETER	SYMBOL	TEST CONDITIONS	MIN.	TYP.	MAX.	UNIT
Static						
Drain-Source Breakdown Voltage	V_{DS}	$V_{GS} = 0\text{ V}, I_D = 250\text{ }\mu\text{A}$	100	-	-	V
V_{DS} Temperature Coefficient	$\Delta V_{DS}/T_J$	Reference to $25\text{ }^\circ\text{C}, I_D = 1\text{ mA}$	-	0.13	-	V/°C
Gate-Source Threshold Voltage	$V_{GS(th)}$	$V_{DS} = V_{GS}, I_D = 250\text{ }\mu\text{A}$	2.0	-	4.0	V
Gate-Source Leakage	I_{GSS}	$V_{GS} = \pm 20\text{ V}$	-	-	± 100	nA
Zero Gate Voltage Drain Current	I_{DSS}	$V_{DS} = 100\text{ V}, V_{GS} = 0\text{ V}$	-	-	25	μA
		$V_{DS} = 80\text{ V}, V_{GS} = 0\text{ V}, T_J = 150\text{ }^\circ\text{C}$	-	-	250	
Drain-Source On-State Resistance	$R_{DS(on)}$	$V_{GS} = 10\text{ V}, I_D = 5.5\text{ A}^b$	-	-	0.27	Ω
Forward Transconductance	g_{fs}	$V_{DS} = 50\text{ V}, I_D = 5.5\text{ A}^b$	2.7	-	-	S
Dynamic						
Input Capacitance	C_{iss}	$V_{GS} = 0\text{ V},$ $V_{DS} = 25\text{ V},$ $f = 1.0\text{ MHz},$ see fig. 5	-	360	-	pF
Output Capacitance	C_{oss}		-	150	-	
Reverse Transfer Capacitance	C_{rss}		-	34	-	
Total Gate Charge	Q_g	$V_{GS} = 10\text{ V},$ $I_D = 9.2\text{ A}, V_{DS} = 80\text{ V},$ see fig. 6 and 13 ^b	-	-	16	nC
Gate-Source Charge	Q_{gs}		-	-	4.4	
Gate-Drain Charge	Q_{gd}		-	-	7.7	
Turn-On Delay Time	$t_{d(on)}$	$V_{DD} = 50\text{ V}, I_D = 9.2\text{ A},$ $R_g = 18\text{ }\Omega, R_D = 5.2\text{ }\Omega,$ see fig. 10 ^b	-	8.8	-	ns
Rise Time	t_r		-	30	-	
Turn-Off Delay Time	$t_{d(off)}$		-	19	-	
Fall Time	t_f		-	20	-	
Internal Drain Inductance	L_D	Between lead, 6 mm (0.25") from package and center of die contact 	-	4.5	-	nH
Internal Source Inductance	L_S		-	7.5	-	
Drain-Source Body Diode Characteristics						
Continuous Source-Drain Diode Current	I_S	MOSFET symbol showing the integral reverse p - n junction diode 	-	-	9.2	A
Pulsed Diode Forward Current ^a	I_{SM}		-	-	37	
Body Diode Voltage	V_{SD}	$T_J = 25\text{ }^\circ\text{C}, I_S = 9.2\text{ A}, V_{GS} = 0\text{ V}^b$	-	-	1.8	V
Body Diode Reverse Recovery Time	t_{rr}	$T_J = 25\text{ }^\circ\text{C}, I_F = 9.2\text{ A}, dl/dt = 100\text{ A}/\mu\text{s}^b$	-	110	260	ns
Body Diode Reverse Recovery Charge	Q_{rr}		-	0.53	1.3	μC
Forward Turn-On Time	t_{on}	Intrinsic turn-on time is negligible (turn-on is dominated by L_S and L_D)				

Notes

- a. Repetitive rating; pulse width limited by maximum junction temperature (see fig. 11).
- b. Pulse width $\leq 300\text{ }\mu\text{s}$; duty cycle $\leq 2\%$.

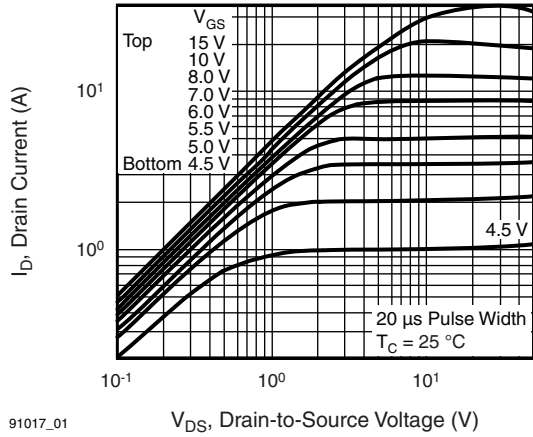
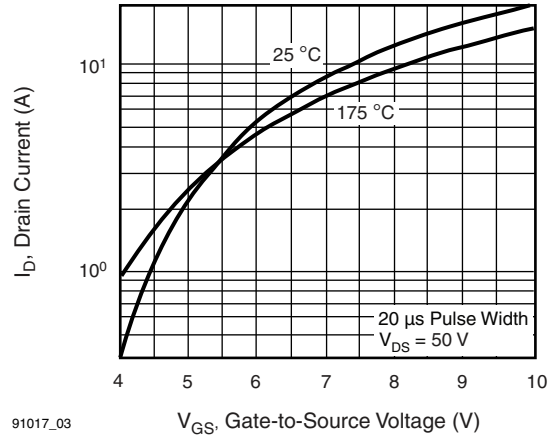
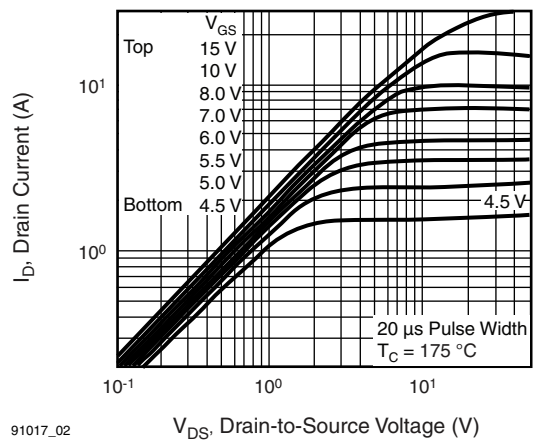
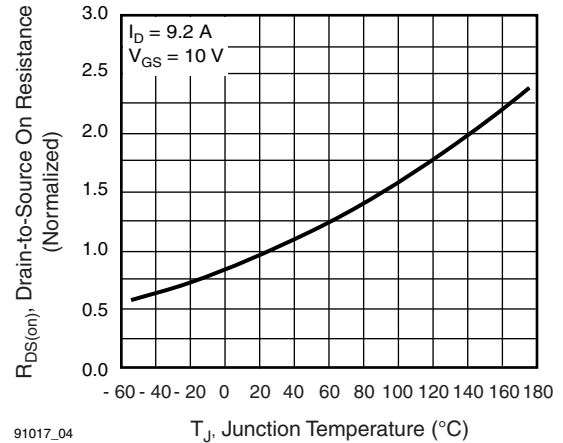
TYPICAL CHARACTERISTICS (25 °C, unless otherwise noted)

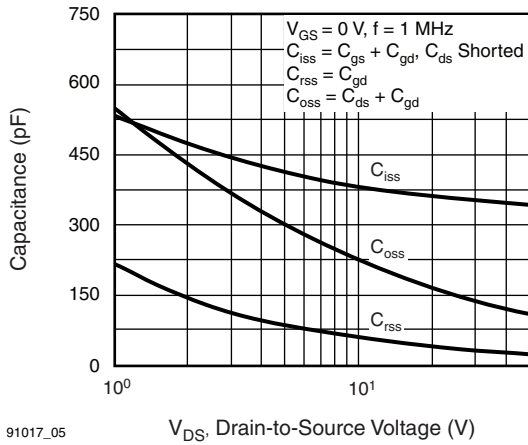
Fig. 1 - Typical Output Characteristics, $T_C = 25\text{ }^\circ\text{C}$

Fig. 3 - Typical Transfer Characteristics

Fig. 2 - Typical Output Characteristics, $T_C = 175\text{ }^\circ\text{C}$

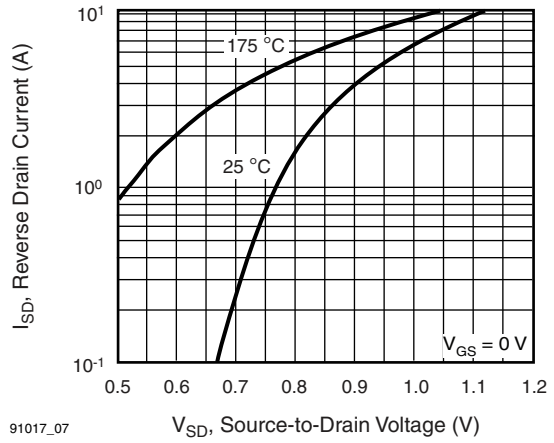
Fig. 4 - Normalized On-Resistance vs. Temperature



91017_05

Fig. 5 - Typical Capacitance vs. Drain-to-Source Voltage



91017_07

Fig. 7 - Typical Source-Drain Diode Forward Voltage

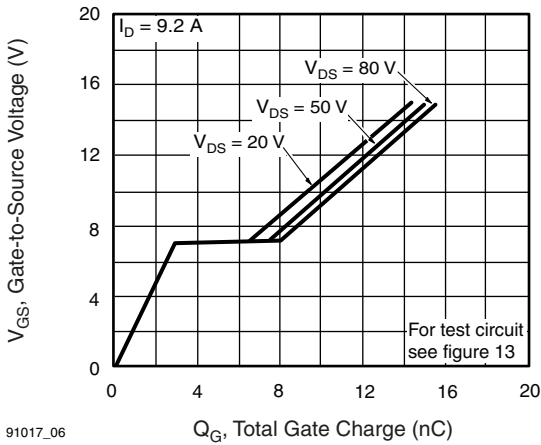

91017_06

Fig. 6 - Typical Gate Charge vs. Gate-to-Source Voltage

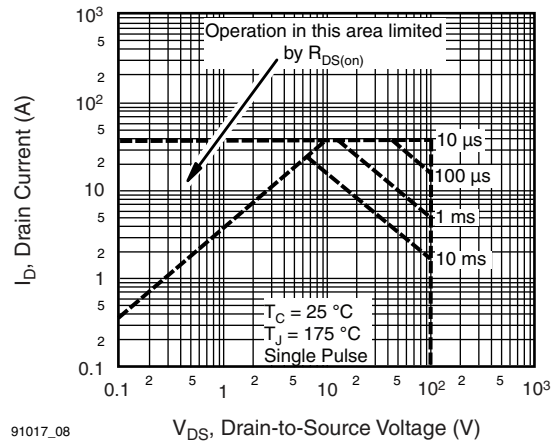

91017_08

Fig. 8 - Maximum Safe Operating Area

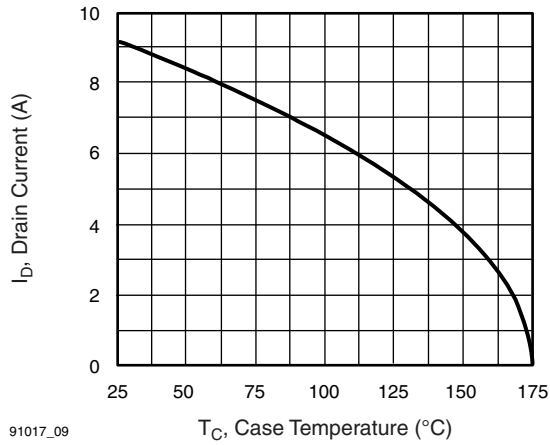

Fig. 9 - Maximum Drain Current vs. Case Temperature

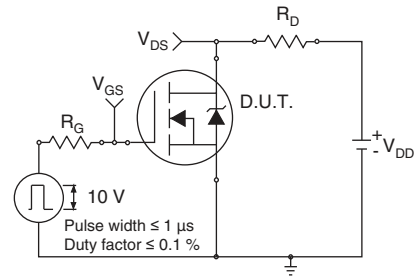

Fig. 10a - Switching Time Test Circuit

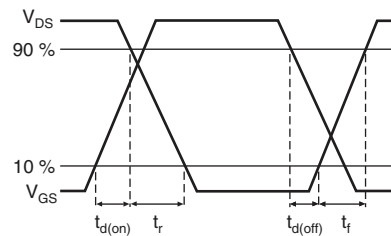

Fig. 10b - Switching Time Waveforms

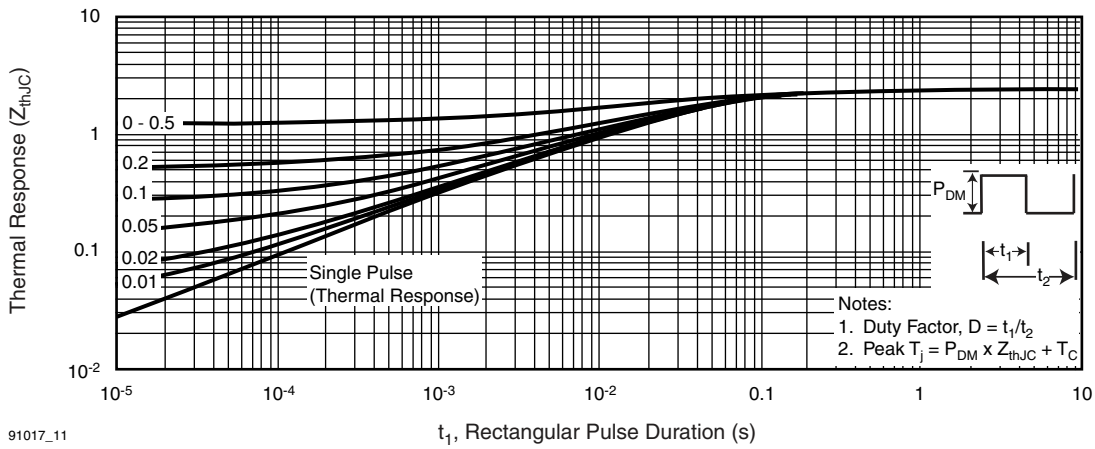

Fig. 11 - Maximum Effective Transient Thermal Impedance, Junction-to-Case

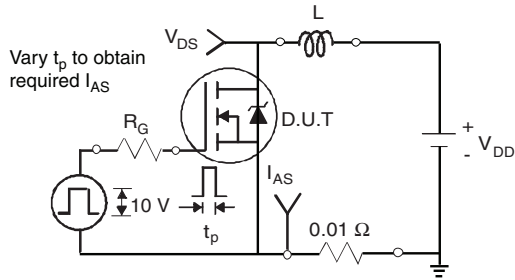

Fig. 12a - Unclamped Inductive Test Circuit

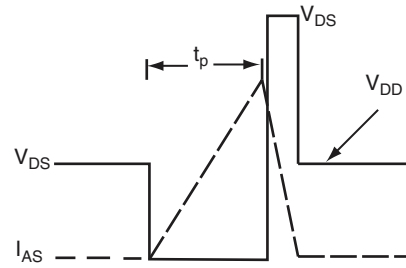

Fig. 12b - Unclamped Inductive Waveforms

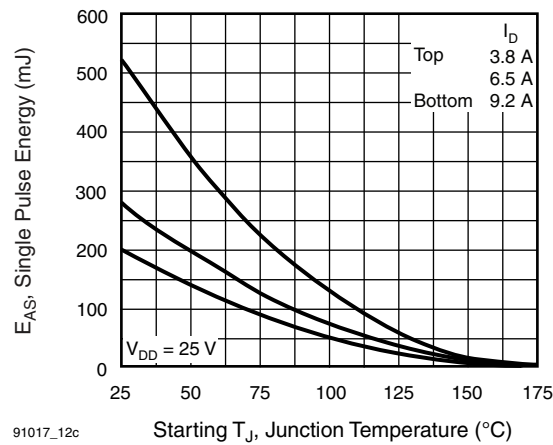

Fig. 12c - Maximum Avalanche Energy vs. Drain Current

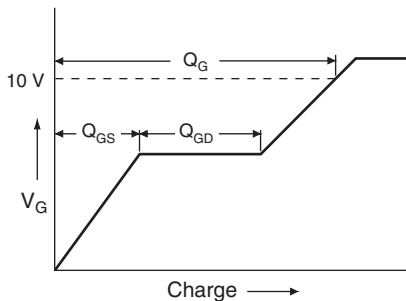

Fig. 13a - Basic Gate Charge Waveform

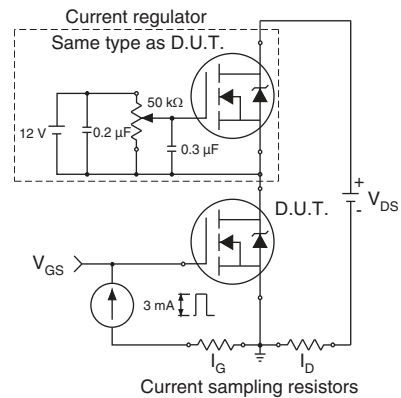

Fig. 13b - Gate Charge Test Circuit

Peak Diode Recovery dV/dt Test Circuit



Note
a. $V_{GS} = 5\text{ V}$ for logic level devices

Fig. 14 - For N-Channel

Vishay Siliconix maintains worldwide manufacturing capability. Products may be manufactured at one of several qualified locations. Reliability data for Silicon Technology and Package Reliability represent a composite of all qualified locations. For related documents such as package/tape drawings, part marking, and reliability data, see www.vishay.com/ppg?91017.

TO-220-1



DIM.	MILLIMETERS		INCHES	
	MIN.	MAX.	MIN.	MAX.
A	4.24	4.65	0.167	0.183
b	0.69	1.02	0.027	0.040
b(1)	1.14	1.78	0.045	0.070
c	0.36	0.61	0.014	0.024
D	14.33	15.85	0.564	0.624
E	9.96	10.52	0.392	0.414
e	2.41	2.67	0.095	0.105
e(1)	4.88	5.28	0.192	0.208
F	1.14	1.40	0.045	0.055
H(1)	6.10	6.71	0.240	0.264
J(1)	2.41	2.92	0.095	0.115
L	13.36	14.40	0.526	0.567
L(1)	3.33	4.04	0.131	0.159
Ø P	3.53	3.94	0.139	0.155
Q	2.54	3.00	0.100	0.118

ECN: X15-0364-Rev. C, 14-Dec-15
DWG: 6031

Note

- M* = 0.052 inches to 0.064 inches (dimension including protrusion), heatsink hole for HVM





Disclaimer

ALL PRODUCT, PRODUCT SPECIFICATIONS AND DATA ARE SUBJECT TO CHANGE WITHOUT NOTICE TO IMPROVE RELIABILITY, FUNCTION OR DESIGN OR OTHERWISE.

Vishay Intertechnology, Inc., its affiliates, agents, and employees, and all persons acting on its or their behalf (collectively, "Vishay"), disclaim any and all liability for any errors, inaccuracies or incompleteness contained in any datasheet or in any other disclosure relating to any product.

Vishay makes no warranty, representation or guarantee regarding the suitability of the products for any particular purpose or the continuing production of any product. To the maximum extent permitted by applicable law, Vishay disclaims (i) any and all liability arising out of the application or use of any product, (ii) any and all liability, including without limitation special, consequential or incidental damages, and (iii) any and all implied warranties, including warranties of fitness for particular purpose, non-infringement and merchantability.

Statements regarding the suitability of products for certain types of applications are based on Vishay's knowledge of typical requirements that are often placed on Vishay products in generic applications. Such statements are not binding statements about the suitability of products for a particular application. It is the customer's responsibility to validate that a particular product with the properties described in the product specification is suitable for use in a particular application. Parameters provided in datasheets and / or specifications may vary in different applications and performance may vary over time. All operating parameters, including typical parameters, must be validated for each customer application by the customer's technical experts. Product specifications do not expand or otherwise modify Vishay's terms and conditions of purchase, including but not limited to the warranty expressed therein.

Except as expressly indicated in writing, Vishay products are not designed for use in medical, life-saving, or life-sustaining applications or for any other application in which the failure of the Vishay product could result in personal injury or death. Customers using or selling Vishay products not expressly indicated for use in such applications do so at their own risk. Please contact authorized Vishay personnel to obtain written terms and conditions regarding products designed for such applications.

No license, express or implied, by estoppel or otherwise, to any intellectual property rights is granted by this document or by any conduct of Vishay. Product names and markings noted herein may be trademarks of their respective owners.

Mouser Electronics

Authorized Distributor

Click to View Pricing, Inventory, Delivery & Lifecycle Information:

[Vishay:](#)

[IRF520PBF](#) [IRF520](#)