

# IRFH5215PbF

HEXFET® Power MOSFET

$V_{DS}$	<b>150</b>	<b>V</b>
$R_{DS(on) \max}$ (@ $V_{GS} = 10V$ )	<b>58</b>	<b>m<math>\Omega</math></b>
$Q_g$ (typical)	<b>21</b>	<b>nC</b>
$R_G$ (typical)	<b>2.3</b>	<b><math>\Omega</math></b>
$I_D$ (@ $T_{c(Bottom)} = 25^\circ C$ )	<b>27</b>	<b>A</b>

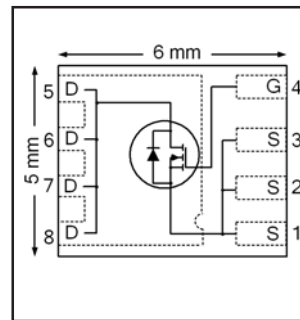

## Applications

- Primary Side Synchronous Rectification
- Inverters for DC Motors
- DC-DC Brick Applications
- Boost Converters

## Features and Benefits

### Features

Low $R_{DSon}$ (< 58 m $\Omega$ )
Low Thermal Resistance to PCB (<1.2 $^\circ C/W$ )
100% $R_g$ tested
Low Profile (<0.9 mm)
Industry-Standard Pinout
Compatible with Existing Surface Mount Techniques
RoHS Compliant Containing no Lead, no Bromide and no Halogen
MSL1, Industrial Qualification

### Benefits

Lower Conduction Losses
Increased Power Density
Increased Reliability
Increased Power Density
Multi-Vendor Compatibility
Easier Manufacturing
Environmentally Friendlier
Increased Reliability

results in  
⇒

Orderable part number	Package Type	Standard Pack		Note
		Form	Quantity	
IRFH5215TRPBF	PQFN 5mm x 6mm	Tape and Reel	4000	
IRFH5215TR2PBF	PQFN 5mm x 6mm	Tape and Reel	400	

## Absolute Maximum Ratings

	Parameter	Max.	Units
$V_{DS}$	Drain-to-Source Voltage	150	V
$V_{GS}$	Gate-to-Source Voltage	$\pm 20$	
$I_D @ T_A = 25^\circ C$	Continuous Drain Current, $V_{GS} @ 10V$	5.0	A
$I_D @ T_A = 70^\circ C$	Continuous Drain Current, $V_{GS} @ 10V$	4.0	
$I_D @ T_{c(Bottom)} = 25^\circ C$	Continuous Drain Current, $V_{GS} @ 10V$	27	
$I_D @ T_{c(Bottom)} = 100^\circ C$	Continuous Drain Current, $V_{GS} @ 10V$	17	
$I_{DM}$	Pulsed Drain Current ①	108	
$P_D @ T_A = 25^\circ C$	Power Dissipation ⑤	3.6	W
$P_D @ T_{c(Bottom)} = 25^\circ C$	Power Dissipation ⑤	104	
	Linear Derating Factor ⑤	0.029	W/ $^\circ C$
$T_J$ $T_{STG}$	Operating Junction and Storage Temperature Range	-55 to + 150	$^\circ C$

Notes ① through ⑤ are on page 8

## Static @ $T_J = 25^\circ\text{C}$ (unless otherwise specified)

	Parameter	Min.	Typ.	Max.	Units	Conditions
$BV_{DSS}$	Drain-to-Source Breakdown Voltage	150	—	—	V	$V_{GS} = 0V, I_D = 250\mu A$
$\Delta BV_{DSS}/\Delta T_J$	Breakdown Voltage Temp. Coefficient	—	0.19	—	V/ $^\circ\text{C}$	Reference to $25^\circ\text{C}, I_D = 1.0\text{mA}$
$R_{DS(on)}$	Static Drain-to-Source On-Resistance	—	45.5	58	m $\Omega$	$V_{GS} = 10V, I_D = 16A$ ③
$V_{GS(th)}$	Gate Threshold Voltage	3.0	—	5.0	V	$V_{DS} = V_{GS}, I_D = 100\mu A$
$\Delta V_{GS(th)}$	Gate Threshold Voltage Coefficient	—	-12	—	mV/ $^\circ\text{C}$	
$I_{DSS}$	Drain-to-Source Leakage Current	—	—	20	$\mu A$	$V_{DS} = 150V, V_{GS} = 0V$
		—	—	250		$V_{DS} = 150V, V_{GS} = 0V, T_J = 125^\circ\text{C}$
$I_{GSS}$	Gate-to-Source Forward Leakage	—	—	100	nA	$V_{GS} = 20V$
	Gate-to-Source Reverse Leakage	—	—	-100		$V_{GS} = -20V$
$g_{fs}$	Forward Transconductance	21	—	—	S	$V_{DS} = 50V, I_D = 16A$
$Q_g$	Total Gate Charge	—	21	32	nC	$V_{DS} = 75V$ $V_{GS} = 10V$ $I_D = 16A$
$Q_{gs1}$	Pre-Vth Gate-to-Source Charge	—	7.2	—		
$Q_{gs2}$	Post-Vth Gate-to-Source Charge	—	2.2	—		
$Q_{gd}$	Gate-to-Drain Charge	—	6.7	—		
$Q_{godr}$	Gate Charge Overdrive	—	4.9	—		
$Q_{sw}$	Switch Charge ( $Q_{gs2} + Q_{gd}$ )	—	8.9	—		
$Q_{oss}$	Output Charge	—	10	—	nC	$V_{DS} = 16V, V_{GS} = 0V$
$R_G$	Gate Resistance	—	2.3	—	$\Omega$	
$t_{d(on)}$	Turn-On Delay Time	—	6.7	—	ns	$V_{DD} = 75V, V_{GS} = 10V$ $I_D = 16A$ $R_G = 1.3\Omega$
$t_r$	Rise Time	—	6.3	—		
$t_{d(off)}$	Turn-Off Delay Time	—	11	—		
$t_f$	Fall Time	—	2.9	—		
$C_{iss}$	Input Capacitance	—	1350	—	pF	$V_{GS} = 0V$
$C_{oss}$	Output Capacitance	—	120	—		$V_{DS} = 50V$
$C_{rss}$	Reverse Transfer Capacitance	—	30	—		$f = 1.0\text{MHz}$

## Avalanche Characteristics

	Parameter	Typ.	Max.	Units
$E_{AS}$	Single Pulse Avalanche Energy ②	—	96	mJ
$I_{AR}$	Avalanche Current ①	—	16	A

## Diode Characteristics

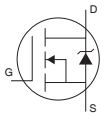
	Parameter	Min.	Typ.	Max.	Units	Conditions
$I_S$	Continuous Source Current (Body Diode)	—	—	27	A	MOSFET symbol showing the integral reverse p-n junction diode. 
$I_{SM}$	Pulsed Source Current (Body Diode) ①	—	—	108		
$V_{SD}$	Diode Forward Voltage	—	—	1.3	V	$T_J = 25^\circ\text{C}, I_S = 16A, V_{GS} = 0V$ ③
$t_{rr}$	Reverse Recovery Time	—	40	60	ns	$T_J = 25^\circ\text{C}, I_F = 16A, V_{DD} = 75V$
$Q_{rr}$	Reverse Recovery Charge	—	370	555	nC	$di/dt = 500A/\mu s$ ③
$t_{on}$	Forward Turn-On Time	Time is dominated by parasitic inductance				

## Thermal Resistance

	Parameter	Typ.	Max.	Units
$R_{\theta JC}$ (Bottom)	Junction-to-Case ④	—	1.2	$^\circ\text{C/W}$
$R_{\theta JC}$ (Top)	Junction-to-Case ④	—	15	
$R_{\theta JA}$	Junction-to-Ambient ⑤	—	35	
$R_{\theta JA} (<10s)$	Junction-to-Ambient ⑤	—	22	

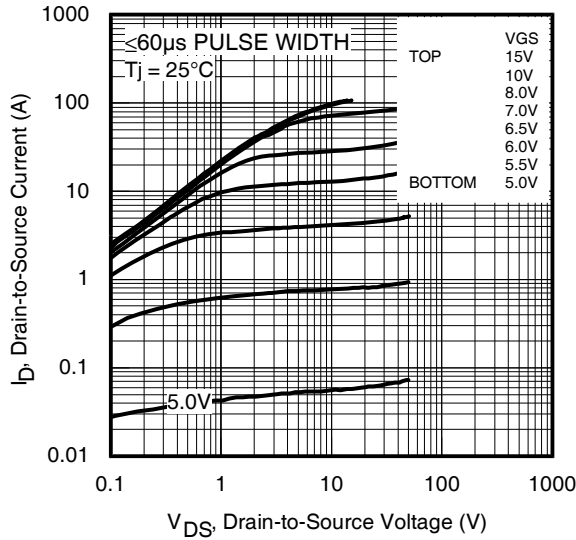

**Fig 1.** Typical Output Characteristics

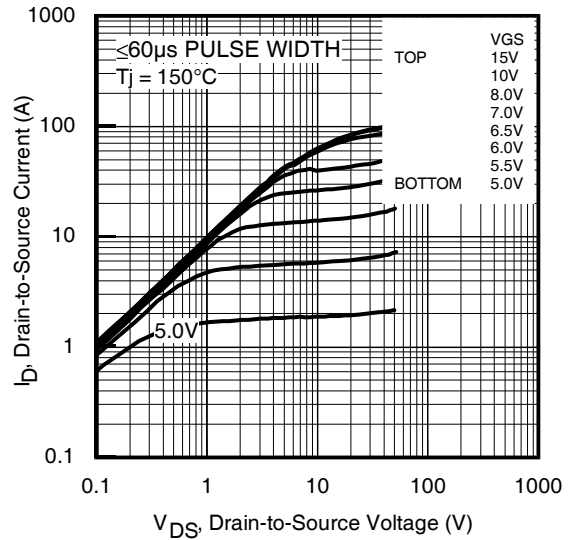

**Fig 2.** Typical Output Characteristics

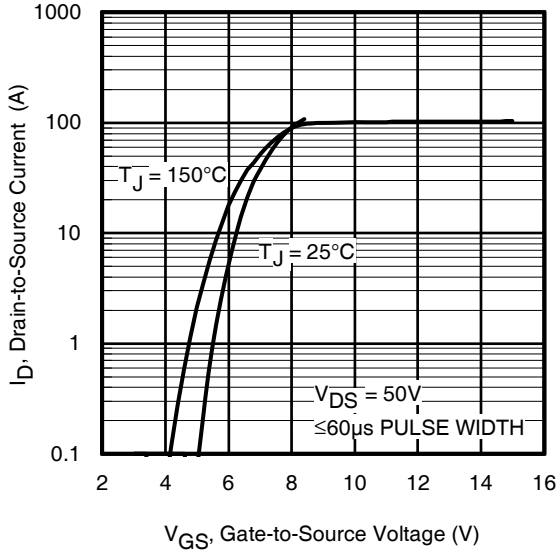

**Fig 3.** Typical Transfer Characteristics

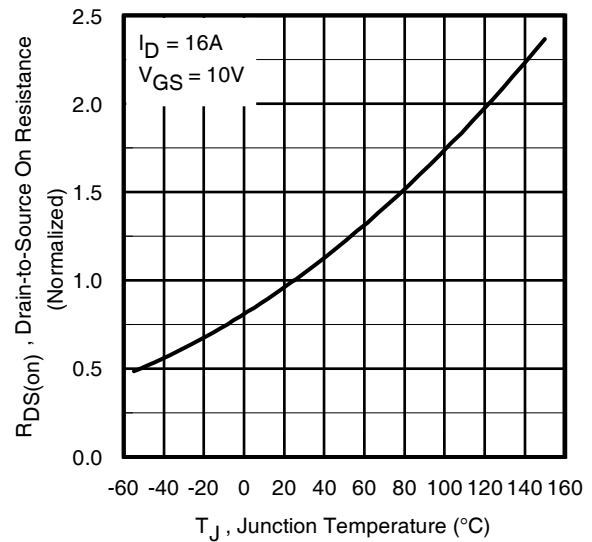

**Fig 4.** Normalized On-Resistance vs. Temperature

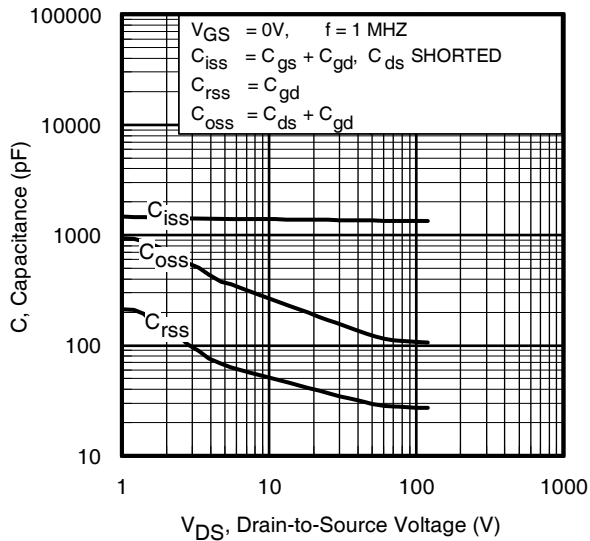

**Fig 5.** Typical Capacitance vs. Drain-to-Source Voltage  
[www.irf.com](http://www.irf.com)

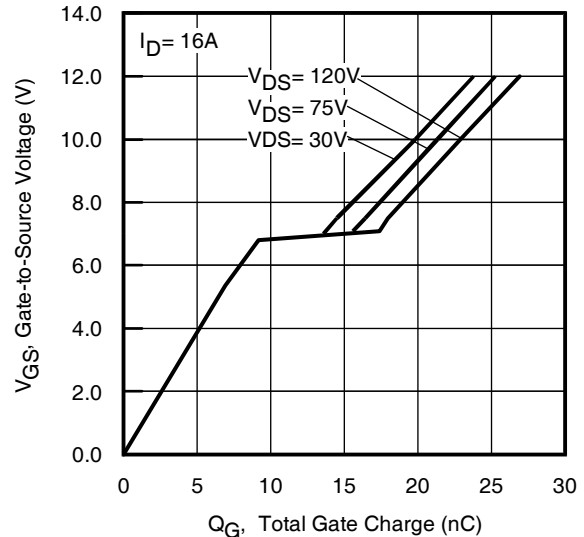

**Fig 6.** Typical Gate Charge vs. Gate-to-Source Voltage

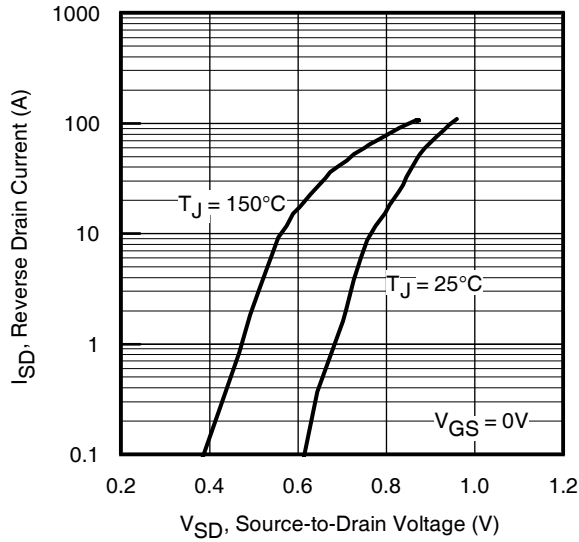

**Fig 7.** Typical Source-Drain Diode Forward Voltage

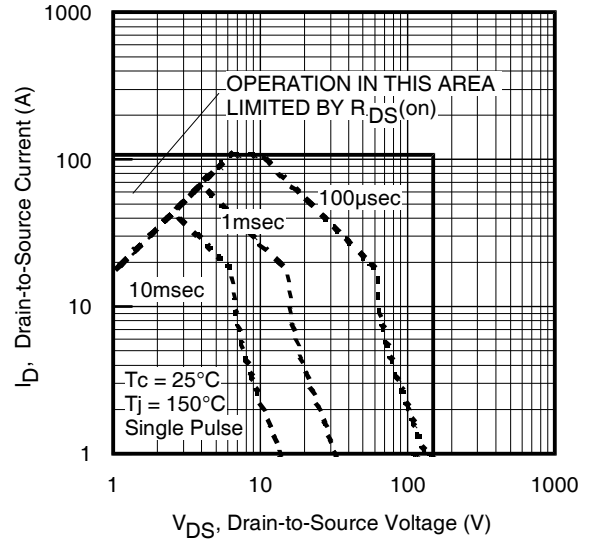

**Fig 8.** Maximum Safe Operating Area

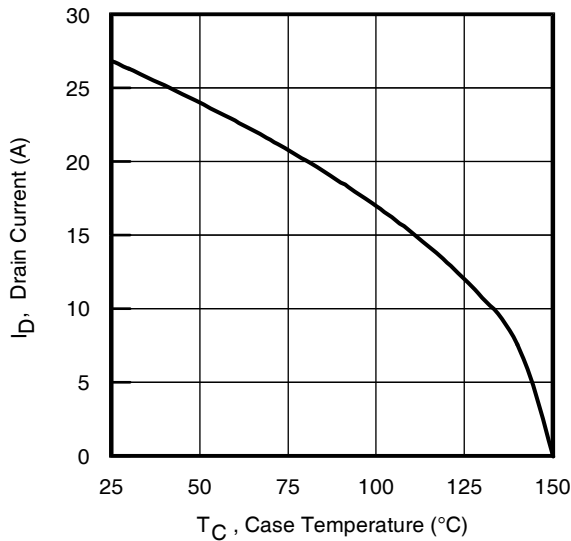

**Fig 9.** Maximum Drain Current vs. Case (Bottom) Temperature

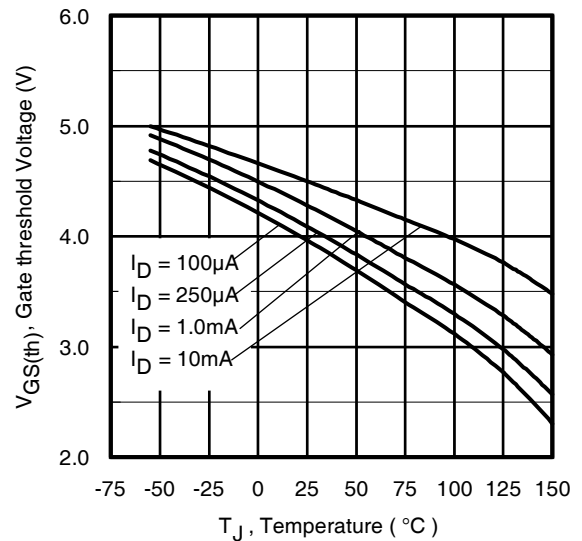

**Fig 10.** Threshold Voltage vs. Temperature

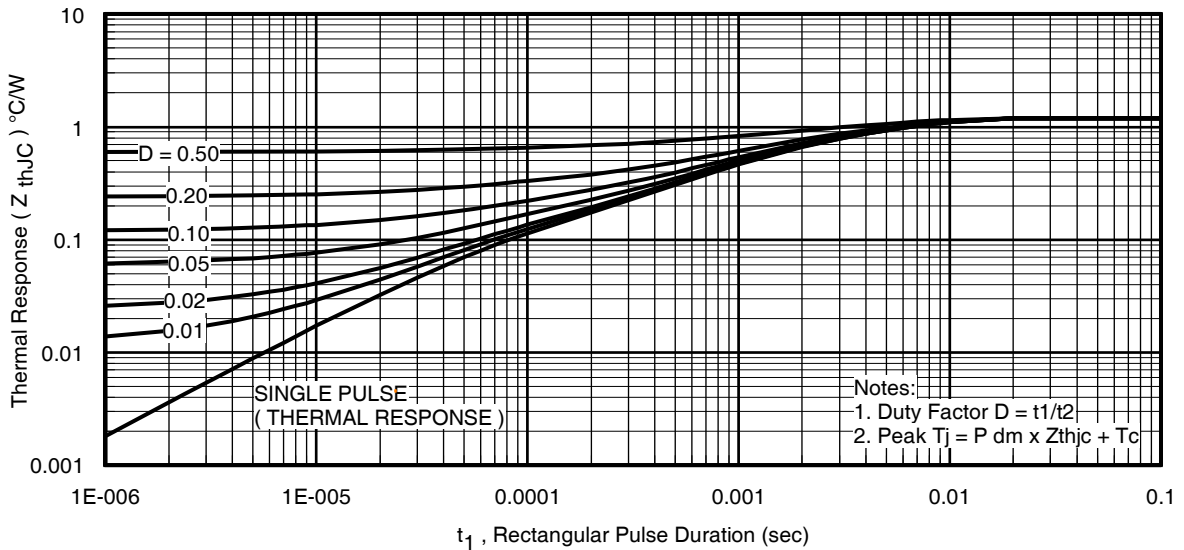

**Fig 11.** Maximum Effective Transient Thermal Impedance, Junction-to-Case (Bottom)

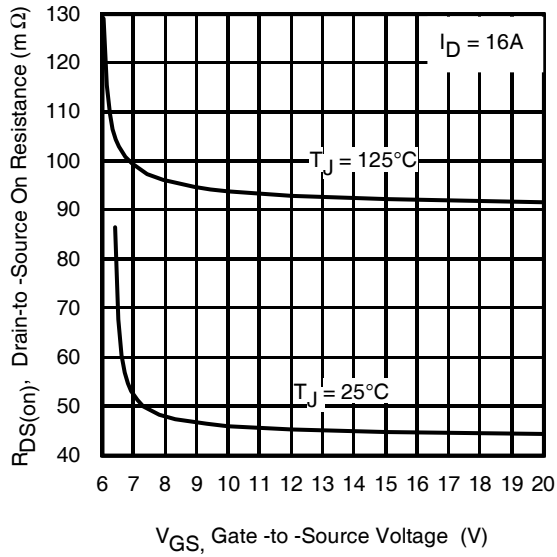

**Fig 12.** On-Resistance vs. Gate Voltage

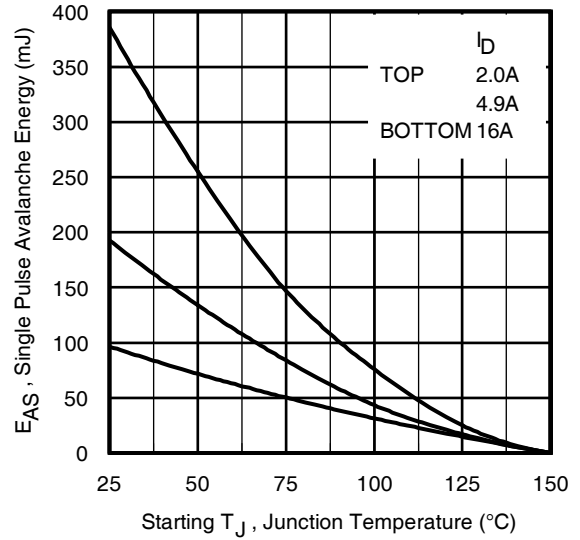

**Fig 13.** Maximum Avalanche Energy vs. Drain Current



**Fig 14a.** Unclamped Inductive Test Circuit



**Fig 14b.** Unclamped Inductive Waveforms



**Fig 15a.** Switching Time Test Circuit

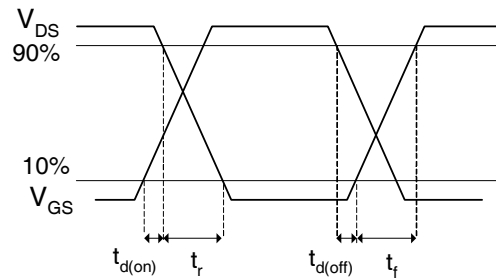

**Fig 15b.** Switching Time Waveforms

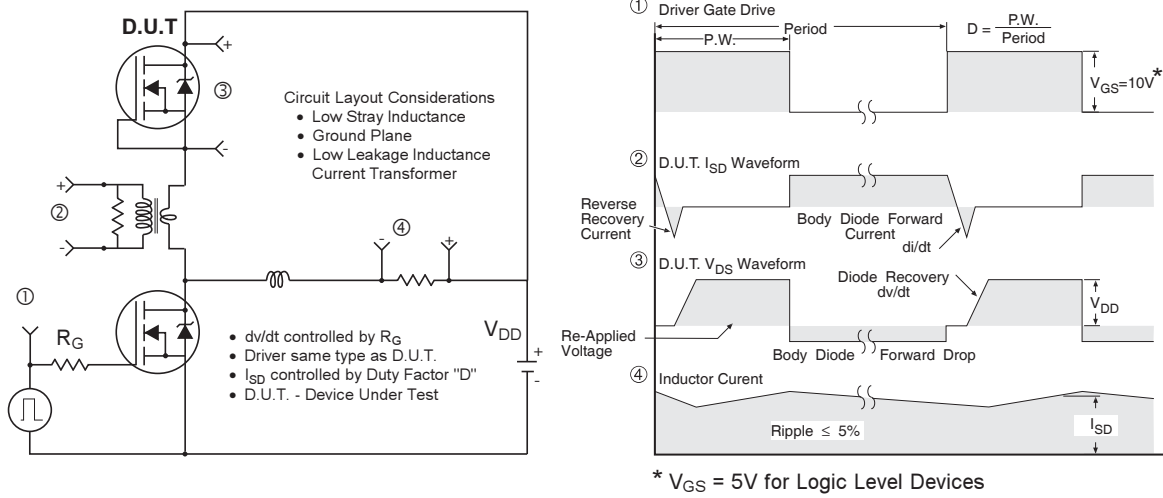

**Fig 16. Peak Diode Recovery  $dv/dt$  Test Circuit for N-Channel HEXFET® Power MOSFETs**

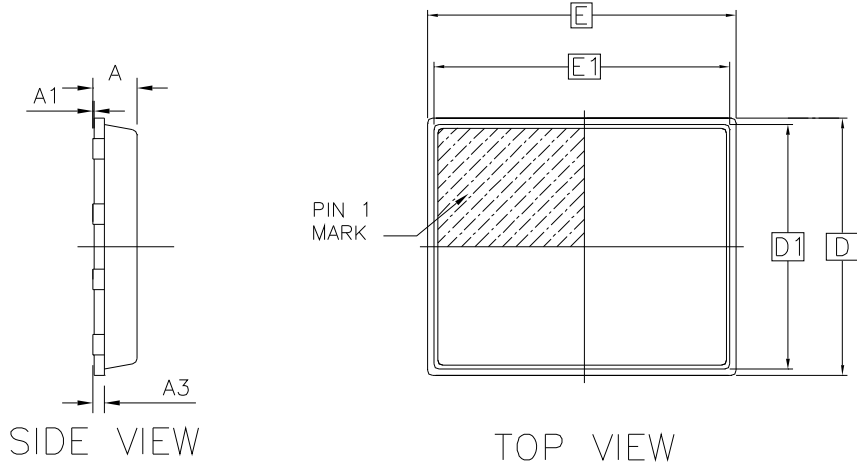

**Fig 17. Gate Charge Test Circuit**

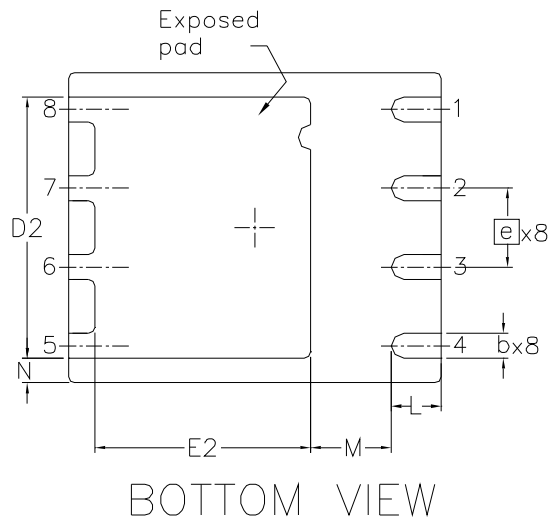

**Fig 18. Gate Charge Waveform**

### PQFN 5x6 Outline "B" Package Details



OUTLINE PQFN 5x6B			
DIM SYMBOL	MIN	NOM	MAX
A	0.80	0.83	0.90
A1	0	0.020	0.05
A3		0.20	REF
b	0.35	0.40	0.47
D		5.00	BSC
D1		4.75	BSC
D2	4.10	4.21	4.30
e		1.27	BSC
E		6.00	BSC
E1		5.75	BSC
E2	3.38	3.48	3.58
L	0.70	0.80	0.90
M		1.30	REF
N		0.40	REF



For footprint and stencil design recommendations, please refer to application note AN-1154 at <http://www.irf.com/technical-info/appnotes/an-1154.pdf>

### PQFN 5x6 Outline "B" Part Marking

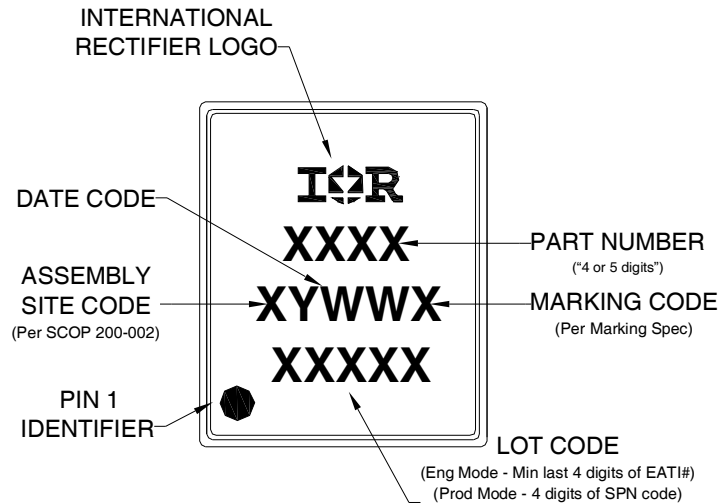

Note: For the most current drawing please refer to IR website at: <http://www.irf.com/package/>

## PQFN 5x6 Outline "B" Tape and Reel

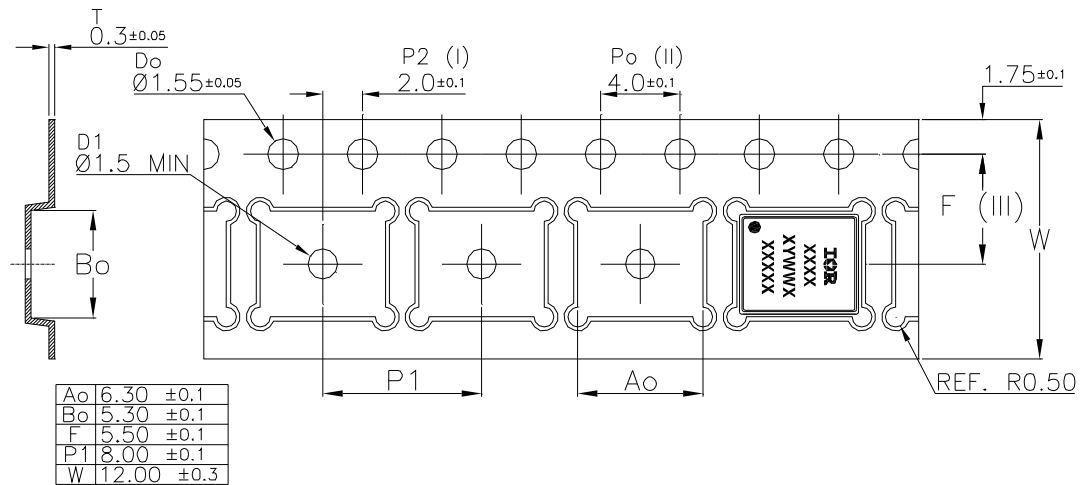

### Qualification information<sup>†</sup>

Qualification level	Industrial <sup>††</sup> (per JEDEC JESD47F <sup>†††</sup> guidelines)	
Moisture Sensitivity Level	PQFN 5mm x 6mm	MSL1 (per JEDEC J-STD-020D <sup>†††</sup> )
RoHS compliant	Yes	

<sup>†</sup> Qualification standards can be found at International Rectifier's web site

<http://www.irf.com/product-info/reliability>

<sup>††</sup> Higher qualification ratings may be available should the user have such requirements.

Please contact your International Rectifier sales representative for further information:

<http://www.irf.com/whoto-call/salesrep/>

<sup>†††</sup> Applicable version of JEDEC standard at the time of product release.

### Notes:

- ① Repetitive rating; pulse width limited by max. junction temperature.
- ② Starting  $T_J = 25^\circ\text{C}$ ,  $L = 0.75\text{mH}$ ,  $R_G = 50\Omega$ ,  $I_{AS} = 16\text{A}$ .
- ③ Pulse width  $\leq 400\mu\text{s}$ ; duty cycle  $\leq 2\%$ .
- ④  $R_\theta$  is measured at  $T_J$  of approximately  $90^\circ\text{C}$ .
- ⑤ When mounted on 1 inch square 2 oz copper pad on 1.5x1.5 in. board of FR-4 material.

Data and specifications subject to change without notice.

International  
**IR** Rectifier

IR WORLD HEADQUARTERS: 101 N. Sepulveda Blvd., El Segundo, California 90245, USA Tel: (310) 252-7105  
TAC Fax: (310) 252-7903

Visit us at [www.irf.com](http://www.irf.com) for sales contact information. 09/11



# Mouser Electronics

Authorized Distributor

Click to View Pricing, Inventory, Delivery & Lifecycle Information:

[International Rectifier:](#)

[IRFH5215TR2PBF](#)