

RoHS

广州市巨宏光电有限公司

Guangzhou Juhong Optoelectronics Co.,Ltd

SPECIFICATION FOR APPROVAL

承认书

CUSTOMER'S CODE

客户代码

DESCRIPTION

品名

大功率发光管 -High power led

SPECIFICATION

规格

9W 红绿蓝 模顶 -9W RGB (45mil)

DATE

送样日期

PART NO.

本厂型号

JH-9RGB14G45-S2A-M

REFERENCE NO.

档案号

NUMBER OF SAMPLE

送样数量

COPY OF ACKNOWLEDGEMENT

承认书份数

Approved By Customer 客户承认	Qualified By 核准	Form Designer 制作

JH-9RGB14G45-S2A-M

High Power LED



Part Number	Chip		Lens Color
	Material	Source Color	
JH-9RGB14G45-S2A-M	InGaN AlGaInP	Full-color	Water Clear



Features

- High brightness RGB LED round package
- Light output intensity grade Viewing angle 140 degree
- Light color: RGB
- RoHS compliant

Dimensions

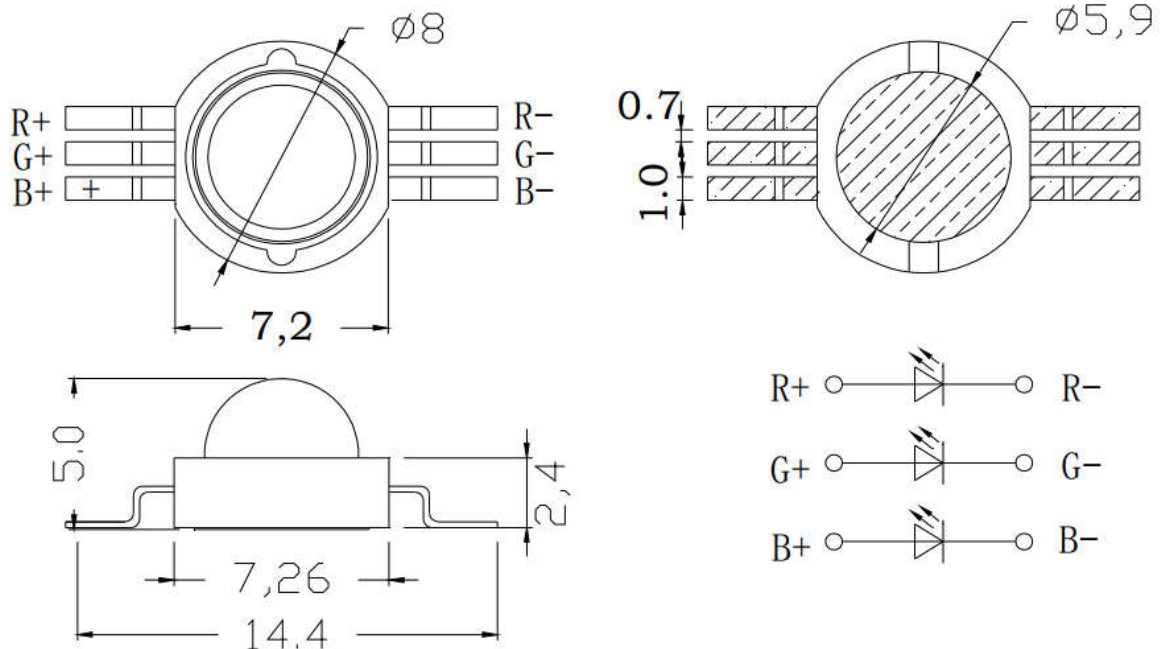

Notes:

1. All dimensions are in millimeters.
2. Tolerance is ± 0.1 mm unless otherwise noted.

Absolute Maximum Rating @ Ta=25°C

Parameter	Symbol	Maximum Rating	Unit
Continuous Forward Current	IF	700	mA
Peak Forward Current (1/10 Duty Cycle, 0.1ms Pulse Width)	IFp	1000	mA
Reverse Voltage	VR	5	V
Power Dissipation	PD	9	W
Electrostatic discharge	ESD	1000	V
Operating Temperature Range	TOPR	-25°C to +60°C	
Storage Temperature Range	TSTG	-35°C to +80°C	
Lead Soldering Temperature (3mm from the base of the epoxy bulb)	TSOL	260°C	

Electrical / Optical Characteristic @ Ta=25°C

Parameter	Symbol	Color	Min.	Typ.	Max.	Unit	Test Condition
Forward Voltage	VF	R	2.2	2.4	2.6	V	IF=700mA
		G	3.2	3.4	3.6	V	IF=700mA
		B	3.2	3.4	3.6	V	IF=700mA
Luminous Flux	Φ	R	70	80	90	Lm	IF=700mA
		G	110	120	140	Lm	IF=700mA
		B	30	40	50	Lm	IF=700mA
Dominant Wavelength	Wld	R	620	622.5	625	nm	IF=700mA
		G	520	522.5	525	nm	IF=700mA
		B	460	462.5	465	nm	IF=700mA
Reverse Current	IR			10	μA	VR=5V	
Viewing Angle	2θ1/2		120	140	deg	IF=700mA	
Recommend Forward Current	IF(rec)	RGB			700	mA	

tolerance of measurement of forward voltage ±0.1V

Typical Electrical / Optical Character Curves

(25 ° Ambient Temperature Unless Otherwise Noted)

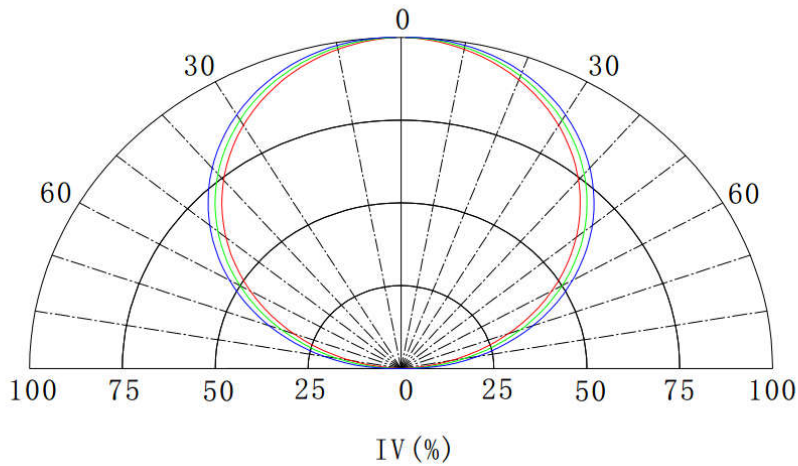

Typical electrical-optical Characteristics curves

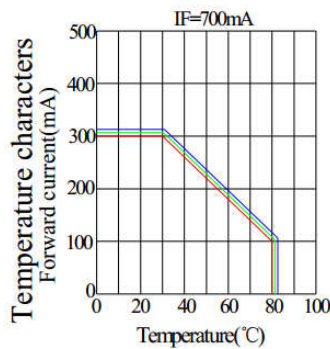
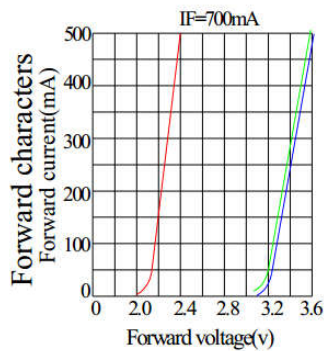

Notes:

The data are an typical presentation of the product, Contact customer service for details of technical information and warranty.
The product is sensitive to static antistatic operation environment is recommended
Products are shipped in either bulk bag package or taping.

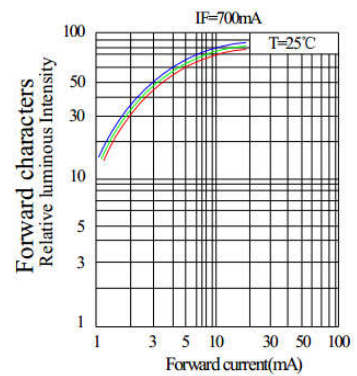
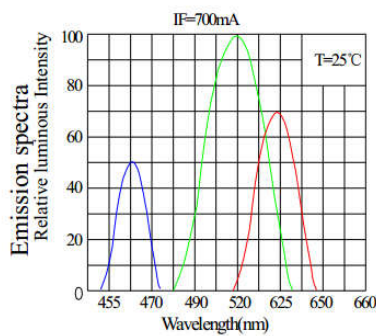
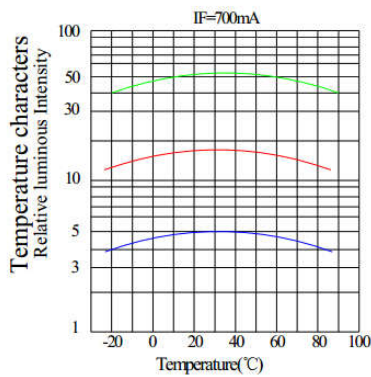

Reliability Tests

Type	Test Item	REF Standard	Test Condition	Note	Number of Damaged
Environmental Sequence	Temperature Cycle	JIS C 7021 (1997)A-4	-20°C*30mins~25°C *5mins~80°C * 30mins	100 cycles	0/100
	High Humidity Heat Cycle	JIS C 7021 (1997)A-5	30°C→65°C, RH= 90% 24hrs/1cycle	10 cycles	0/100
	High Temperature Storage	JIS C 7021 (1997)B-10	Ta= 80°C	1000h	0/100
	Humidity Heat Storage	JIS C 7021 (1997)B-11	Ta=60°C RH=90%	1000h	0/100
	Low Temperature Storage	JIS C 7021 (1997)B-12	Ta= -30°C	1000h	0/100
Operation Sequence	DC Operating Life	JIS C 7035 (1985)	Ta= 25°C, IF=700mA	1000h	0/100
	High Humidity Heat Life Test	*	Ta=60°C RH=90% IF=700mA	500h	0/100
	Low Temperature Life Test	*	Ta= -20°C, IF=700mA	1000h	0/100
Destructive Sequence	Resistance to Soldering Heat	JIS C 7021 (1997)A-11	Tsol=260±5°C, 10sec (3mm from the base of the epoxy bulb)	1 time	0/20
	Solderability	JIS C 7021 (1997)A-2	Tsol=235 ±5°C, 5sec (Using flux)	1 time (over 95%)	0/20
	Lead Pull/Bend Test	JIS C 7021 (1997)A-11	Load 2.5N (0.25kgf) 0° → 90° →0° Bending 3 times	No noticeable damage	0/20

*Refer to reliability test standard specification for in this line.

Cautions

The LED's are devices which are materialized by combining blue LED's and special phosphors. Consequently the color of the LED's is changed a little by an operating current. Care should be taken after due consideration when using LED's.

(1) Moisture Proof Package:

When moisture is absorbed into package it may vaporize and expand during soldering. There is a possibility that this can cause exfoliation of the contacts and damage to the optical characteristics of the LED's. For this reason, the moisture proof package is used to keep moisture to a minimum in the package.

(2) Storage Conditions

Before opening the package:

The LED's should be kept at 30°C or less and 60%RH or less. The LED's should be used within a year. When storing the LED's, moisture proof packaging with absorbent material (silica gel) is recommended.

After opening the package:

The LED's should be kept at 30°C or less and 50%RH or less. The LED's should be soldered within 168 hours (7days) after opening the package. If unused LED's remain, they should be stored in moisture proof packages, such as sealed containers with packages of moisture absorbent material (silica gel). It is also recommended to return the LED's to the original moisture proof bag and to reseal the moisture proof bag again. If the moisture absorbent material (silica gel) has faded away or the LED's have exceeded the storage time, baking treatment should be performed using the following conditions. Baking treatment: more than 48 hours at 65±5°C. LEDGUHON LED electrode and lead free are comprised of a silver plated copper alloy. The silver surface may be affected by environments which contain corrosive gases and so on. Please Avoid conditions which may cause the LED to corrode, tarnish or discolor. This corrosion or discoloration might lower solderability or might affect on optical characteristics. Please avoid rapid transitions in ambient temperature, especially in high humidity environments where condensation can occur.

(3) Heat Generation

Thermal design of the end product is of paramount importance. Please consider the heat generation of the LED when making the system design. The coefficient of temperature increase per input electric power is affected by the thermal resistance of the circuit board and density of LED placement on the board, as well as other components. It is necessary to avoid intense heat generation and operate within the maximum ratings given in this specification. The operating current should be decided after considering the ambient maximum temperature of LED's.

(4) Cleaning

It is recommended that isopropyl alcohol be used as a solvent for cleaning the LED's. when using other solvents, it should be confirmed beforehand whether the solvents will dissolve the package and the resin or not. Freon solvents should not be used to clean the LED's because of worldwide regulations. Do not clean the LED's by the ultrasonic. When it is absolutely necessary, the influence of ultrasonic cleaning on the LED's depends on factors such as ultrasonic power and the assembled condition. Before cleaning, a pre-test should be done to confirm whether any damage to the LED's will occur °C

(5) Static Electricity

Static electricity or surge voltage damages the LED's. It is recommended that a wrist band or an anti-electrostatic glove be used when handling the LED's. All devices, equipment and machinery must be properly grounded. It is recommended that measures be taken against surge voltage to the equipment that mounts the LED's. When inspecting the final products in which LED's were assembled, it is recommended to check. Whether the assembled LED's are damaged by static electricity or not, it is easy to find static-damaged LED's by a light -on

test or a VF test at a lower current (below 1mA is recommended). Damaged LED's will show some unusual characteristics such as the leak current remarkably increases, the forward voltage becomes lower, or the LED's do not light at the low current. Criteria ($V_f > 2.0V$ at $I_f = 0.5mA$)

(6) Others

Care must be taken to ensure that the reverse voltage will not exceed the absolute maximum rating when using the LED's with matrix drive. The LED light output is strong enough to injure human eyes. Precautions must be taken to prevent looking directly at the LED's with unaided eyes for more than a few seconds. Flashing lights have been known to cause discomfort in people, you can prevent this by taking precautions during use. Also, people should be cautious when using equipment that has had LED's incorporated into it. The LED's described in this brochure are intended to be used for ordinary electronic equipment (such as office equipment, communications equipment, measurement instruments and household appliances) Consult LEDGUHON's sales staff in advance for information on the applications in which exceptional quality and reliability are required, particularly when the failure or malfunction of the LED's may directly jeopardize life or health (such as for airplanes, aerospace, submersible repeaters, nuclear reactor control systems, automobile, traffic control equipment, life support systems and safety devices). User shall not reverse engineer by disassembling or analysis of the LED's without having prior written consent from LEDGUHON when defective LED's are found, the User shall inform LEDGUHONG directly before disassembling or analysis. The formal specifications must be exchanged and signed by both parties before large volume purchase begins. The appearance and specifications of the product may be modified for improvement without notice.