



ST1803DFX

HIGH VOLTAGE FAST-SWITCHING NPN POWER TRANSISTOR

- NEW SERIES, ENHANCED PERFORMANCE
- FULLY INSULATED PACKAGE (U.L. COMPLIANT) FOR EASY MOUNTING
- INTEGRATED FREE WHEELING DIODE
- HIGH VOLTAGE CAPABILITY (> 1500 V)
- HIGH SWITCHING SPEED
- TIGHTER hfe CONTROL
- IMPROVED RUGGEDNESS

APPLICATIONS:

- HORIZONTAL DEFLECTION FOR COLOR TVS UP TO 29 INCHES

DESCRIPTION

The ST1803DFX is manufactured using Diffused Collector technology for more stable operation Vs base drive circuit variations resulting in very low worst case dissipation.

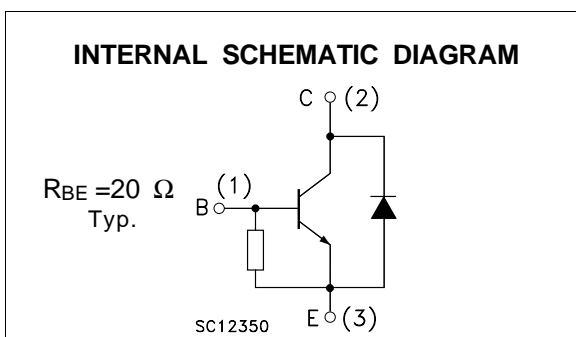
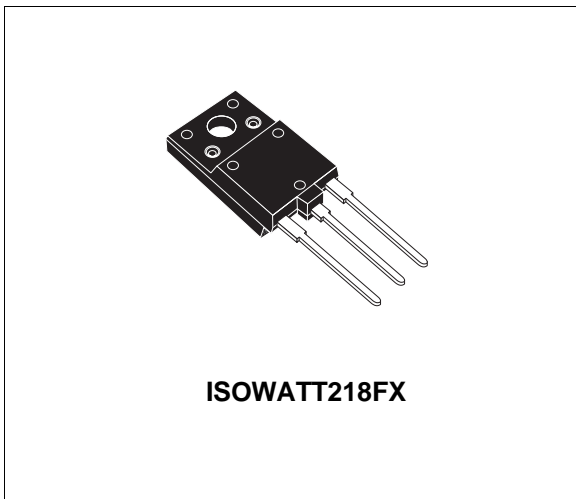

ABSOLUTE MAXIMUM RATINGS

Symbol	Parameter	Value	Unit
V_{CBO}	Collector-Base Voltage ($I_E = 0$)	1500	V
V_{CEO}	Collector-Emitter Voltage ($I_B = 0$)	600	V
V_{EBO}	Emitter-Base Voltage ($I_C = 0$)	7	V
I_C	Collector Current	10	A
I_{CM}	Collector Peak Current ($t_p < 5$ ms)	15	A
I_B	Base Current	4	A
P_{tot}	Total Dissipation at $T_C = 25$ °C	60	W
V_{isol}	Insulation Withstand Voltage (RMS) from All Three Leads to External Heatsink	2500	V
T_{stg}	Storage Temperature	-65 to 150	°C
T_j	Max. Operating Junction Temperature	150	°C

THERMAL DATA

$R_{thj-case}$	Thermal Resistance Junction-case	Max	2.1	$^{\circ}C/W$
----------------	----------------------------------	-----	-----	---------------

ELECTRICAL CHARACTERISTICS ($T_{case} = 25^{\circ}C$ unless otherwise specified)

Symbol	Parameter	Test Conditions	Min.	Typ.	Max.	Unit
I_{CES}	Collector Cut-off Current ($V_{BE} = 0$)	$V_{CE} = 1500 V$ $V_{CE} = 1500 V \quad T_j = 125^{\circ}C$			1 2	mA mA
I_{EBO}	Emitter Cut-off Current ($I_C = 0$)	$V_{EB} = 4 V$	130		400	mA
$V_{(BR)EBO}$	Emitter-Base Breakdown Voltage ($I_C = 0$)	$I_E = 700 mA$	7			V
$V_{CE(sat)*}$	Collector-Emitter Saturation Voltage	$I_C = 4 A \quad I_B = 0.8 A$ $I_C = 4 A \quad I_B = 1.2 A$		3	5 1.5	V V
$V_{BE(sat)*}$	Base-Emitter Saturation Voltage	$I_C = 4 A \quad I_B = 0.8 A$			1.2	V
h_{FE*}	DC Current Gain	$I_C = 1 A \quad V_{CE} = 5 V$ $I_C = 4.5 A \quad V_{CE} = 1 V$ $I_C = 4.5 A \quad V_{CE} = 5 V$	10 5	15 5	20 9	
V_F	Diode Forward Voltage	$I_F = 5 A$		1.5	2	V
t_s t_f	INDUCTIVE LOAD Storage Time Fall Time	$I_C = 4 A \quad I_{Bon(END)} = 0.8 A$ $L_B = 5 \mu H \quad V_{BB} = -2.5 V$ $f = 16 KHz$ (see figure 1)		2.7 0.3	4 0.6	μs μs

* Pulsed: Pulse duration = 300 μs , duty cycle 1.5 %

Safe Operating Area

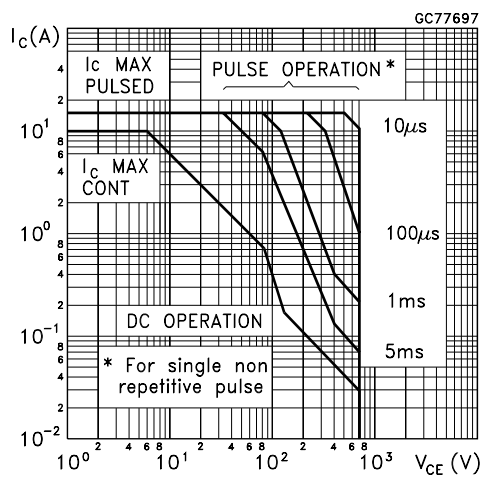

Thermal Impedance

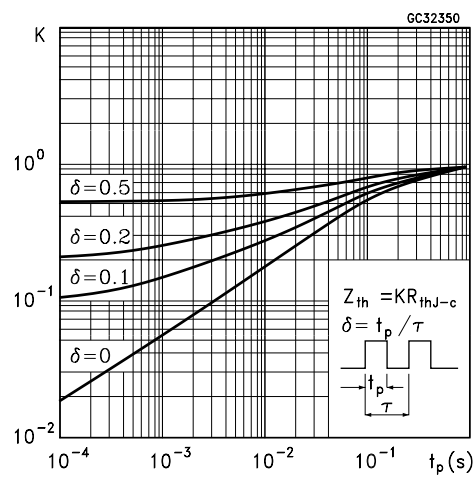

Derating Curve

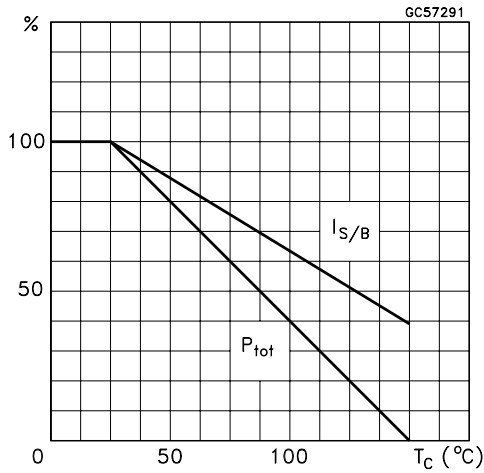

Output Characteristics

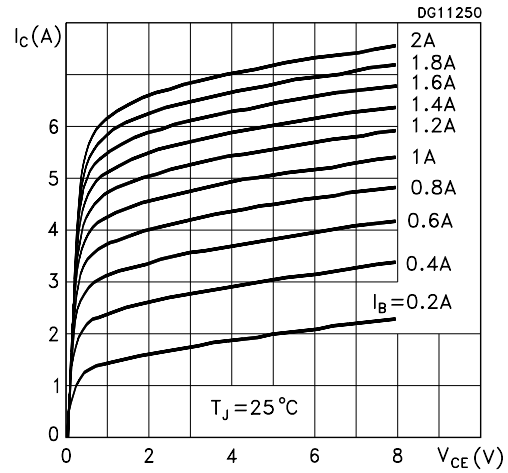

Collector Emitter Saturation Voltage

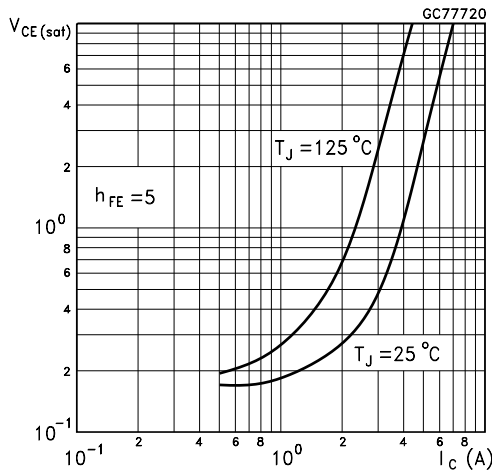

Base Emitter Saturation Voltage

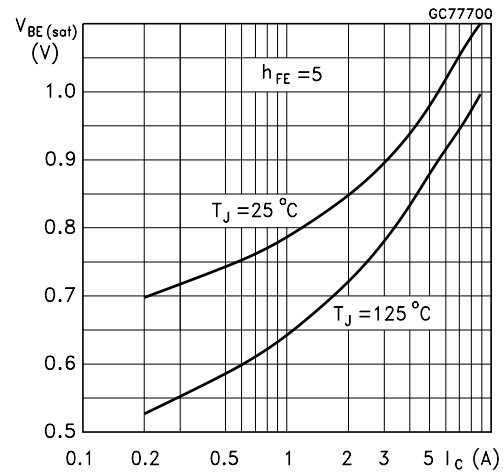

DC Current Gain

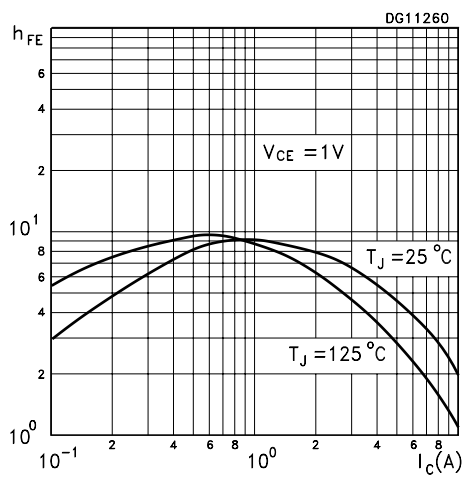

DC Current Gain

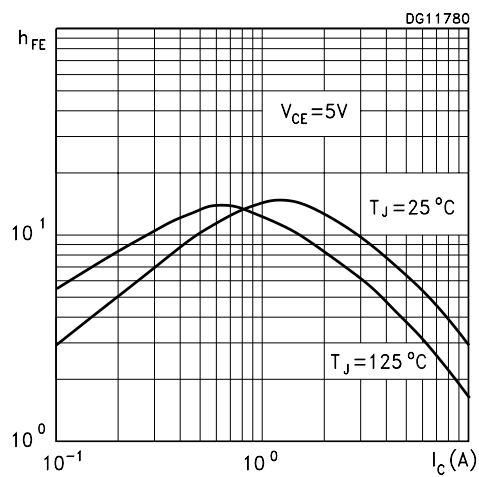

Power Losses

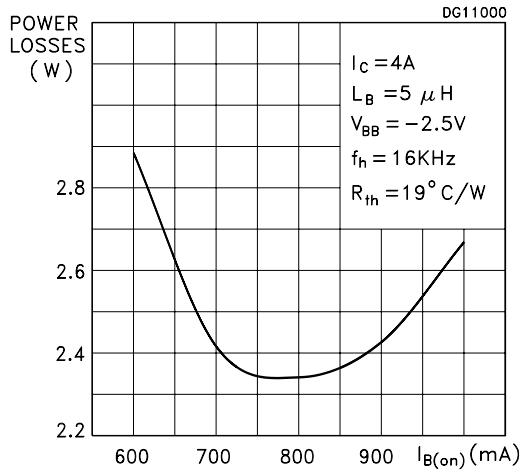

Switching Time Inductive Load

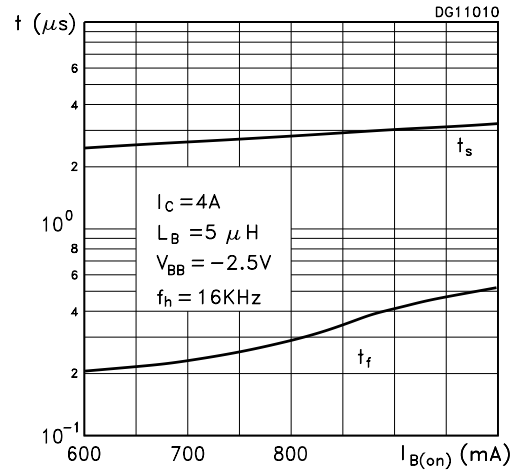

Reverse Biased SOA

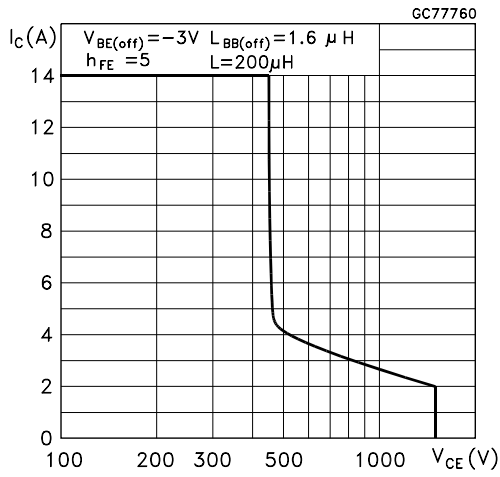
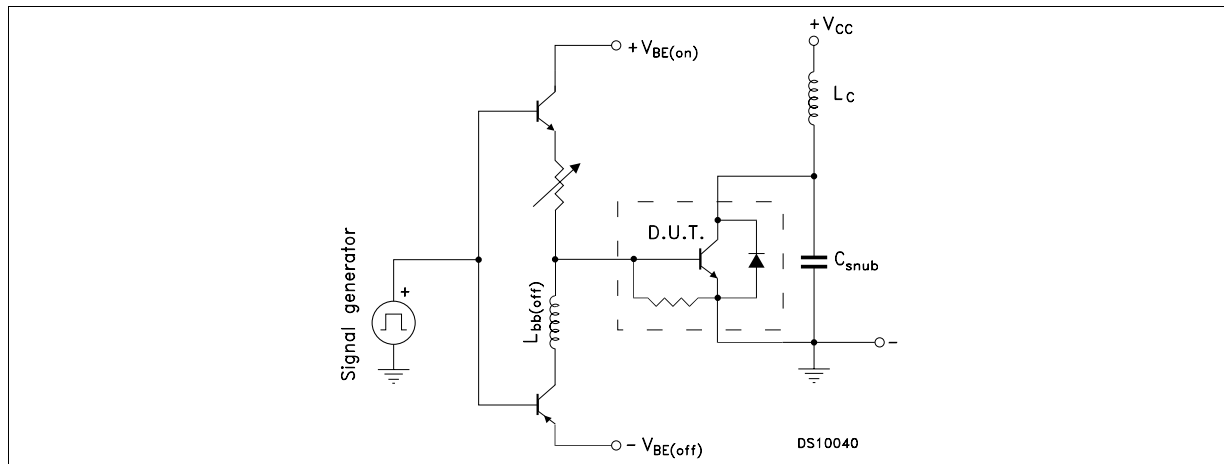
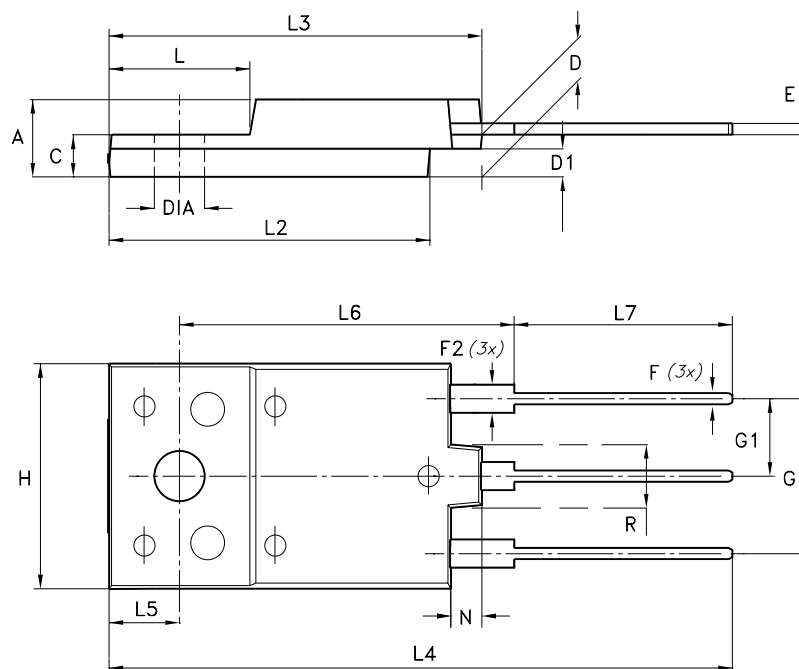

Figure 1: Inductive Load Switching Test Circuit.



ISOWATT218FX MECHANICAL DATA

DIM.	mm			inch		
	MIN.	TYP.	MAX.	MIN.	TYP.	MAX.
A	5.30		5.70	0.209		0.224
C	2.80		3.20	0.110		0.126
D	3.10		3.50	0.122		0.138
D1	1.80		2.20	0.071		0.087
E	0.80		1.10	0.031		0.043
F	0.65		0.95	0.026		0.037
F2	1.80		2.20	0.071		0.087
G	10.30		11.50	0.406		0.453
G1		5.45			0.215	
H	15.30		15.70	0.602		0.618
L	9.80		10.20	0.386		0.402
L2	22.80		23.20	0.898		0.913
L3	26.30		26.70	1.035		1.051
L4	43.20		44.40	1.701		1.748
L5	4.30		4.70	0.169		0.185
L6	24.30		24.70	0.957		0.972
L7	14.60		15.00	0.575		0.591
N	1.80		2.20	0.071		0.087
R	3.80		4.20	0.150		0.165
DIA	3.40		3.80	0.134		0.150



- Weight : 5.6 g (typ.)
- Maximum Torque (applied to mounting flange) Recommended: 0.55 Nm; Maximum: 1 Nm
- The side of the dissipator must be flat within 80 μ m

Information furnished is believed to be accurate and reliable. However, STMicroelectronics assumes no responsibility for the consequences of use of such information nor for any infringement of patents or other rights of third parties which may result from its use. No license is granted by implication or otherwise under any patent or patent rights of STMicroelectronics. Specification mentioned in this publication are subject to change without notice. This publication supersedes and replaces all information previously supplied. STMicroelectronics products are not authorized for use as critical components in life support devices or systems without express written approval of STMicroelectronics.

The ST logo is a trademark of STMicroelectronics.
All other names are the property of their respective owners.

© 2003 STMicroelectronics – All Rights reserved
STMicroelectronics GROUP OF COMPANIES

Australia - Belgium - Brazil - Canada - China - Czech Republic - Finland - France - Germany - Hong Kong - India - Israel - Italy - Japan -
Malaysia - Malta - Morocco - Singapore - Spain - Sweden - Switzerland - United Kingdom - United States.

<http://www.st.com>