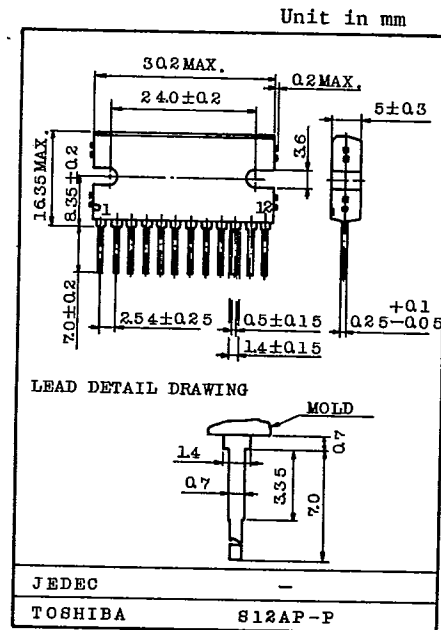

TA7227P

T-74-05-01

5.5W DUAL POWER AMPLIFIER**CAR RADIO, CAR STEREO OUTPUT****AUDIO POWER AMPLIFIER**

- Dual Mode or Bridge Connection Mode Type.
- Some Protection Circuits Included
Thermal Protection, Over Voltage Protection,
Current Limiter, BTL DC Short Protection.
- Wide Operating Voltage Range : $V_{CC(opr)}=8\sim 18V$
- A Chassis Mounting is Easily Designed Using SIP
(Single in Line Package) 12 Pins.
- Very Few External Parts.
- This Power IC Obtains High Output Power by
Bridge Connection : $P_{OUT}=17W$ (Typ.)
at $V_{CC}=13.2V$, $R_L=4\Omega$, $THD=10\%$
- Dual Mode : Minimum Load Impedance is 2 ohm.
- BTL Mode : Minimum Load Impedance is 4 ohm.

**MAXIMUM RATINGS (Ta=25°C)**

CHARACTERISTIC	SYMBOL	RATING	UNIT
Peak Supply Voltage	V_{CC} surge	45	V
D.C Supply Voltage (30 sec)	V_{CC} DC	25	V
Operating Supply Voltage	V_{CC} opr	18	V
Output Current (peak)	I_O (peak)	4.5	A
Power Dissipation	P_D	25	W
Operating Temperature	T_{opr}	-30 ~ 75	°C
Storage Temperature	T_{stg}	-55 ~ 150	°C

(Note) Less than 2 ohm (Dual mode) or 4 ohm (BTL mode) load impedance is not recommended from allowable power dissipation and over current limiter.

TOSHIBA

TA7227P

T-74-05-01

ELECTRICAL CHARACTERISTICS

(Unless otherwise specified, $V_{CC}=13.2V$, $R_L=4\Omega$, $R_g=600\Omega$, $f=1kHz$, $T_a=25^\circ C$,
Dual mode (Fig.-1) or BTL connection (Fig.-2))

CHARACTERISTIC	SYMBOL	TEST CIR-CUIT	TEST CONDITION	MIN.	TYP.	MAX.	UNIT	
Quiescent Current	ICCQ	-	-	-	85	200	mA	
Output Power	P _{OUT}	-	THD=10%	Dual	4.5	5.5	-	W
				BTL	14	17.0	-	
Output Power	P _{O2}	-	THD=10%, $R_L=2\Omega$	Dual	-	8.0	-	W
Maximum Output Power	P _{OM}	-	$V_{IN}=100mV_{rms}$	Dual	-	9.0	-	W
				BTL	-	30	-	
Total Harmonic Distortion	THD	-	P _{OUT} =1W	Dual	-	0.2	1.5	%
				BTL	-	0.3	1.5	
Voltage Gain	G _V	-	$V_{OUT}=0dBm$ (Note 1)	52.5	54.0	55.5	dB	
Channel Balance	ΔG_V	-	$V_{OUT}=0dBm$	-	0	± 1.0	dB	
Channel Separation	CT	-	$V_{OUT}=0dBm$	-	-45	-	dB	
Ripple Rejection	R.R.	-	f=100Hz	Dual	-	-20	-	dB
				BTL	-	-29	-	
Input Resistance	R _{IN}	-	-	20	35	50	k Ω	
Output Noise Voltage	V _{NO}	-	$R_g=10k\Omega$, BW=50~20kHz	-	1.0	2.0	mV _{rms}	

Note 1. Voltage gain G_V is fixed by internal resistance. The typical voltage gain is 54dB. When you need lower voltage gain than 54dB, connect resistance R(*) which is shown on Fig.-1 or Fig.-2. To get stable action of IC, voltage gain G_V minimum limit is 40dB.

- Capacitor C₅, C₆ are demanded good temperature characteristic and we recommend large value capacitors more than 0.1 μ F to avoid application problems.
- Don't short output PINS (PIN2 and PIN10) to the GND directly, this situation gives the damage to the IC.
To avoid destruction of IC, please put in inductance (about 1.5 μ H) between output pin and load. (BTL Application mode)

AUDIO LINEAR IC

TA7227P

T-74-05-01

TEST CIRCUIT

FIG.1 DUAL MODE

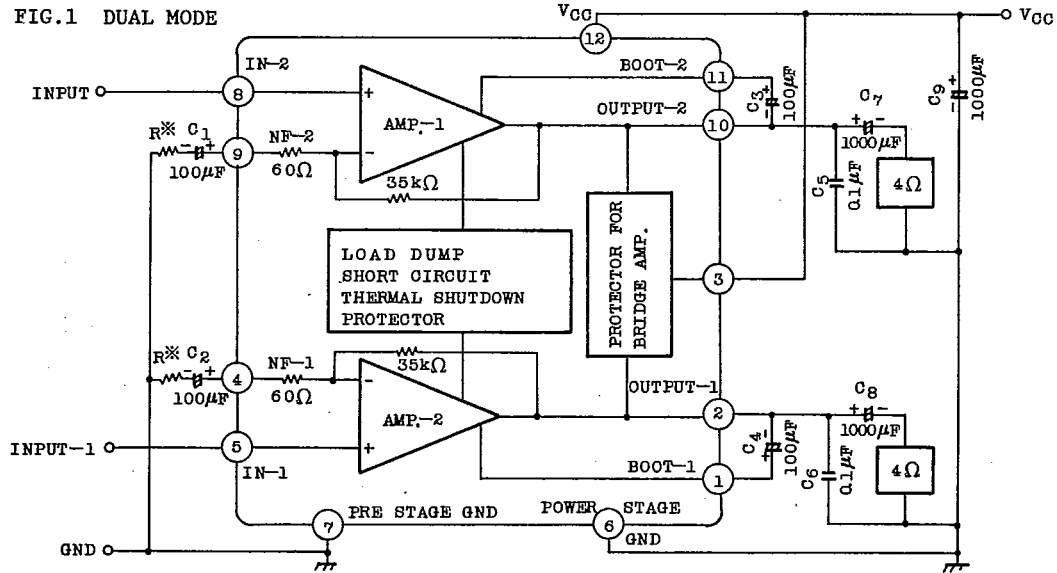
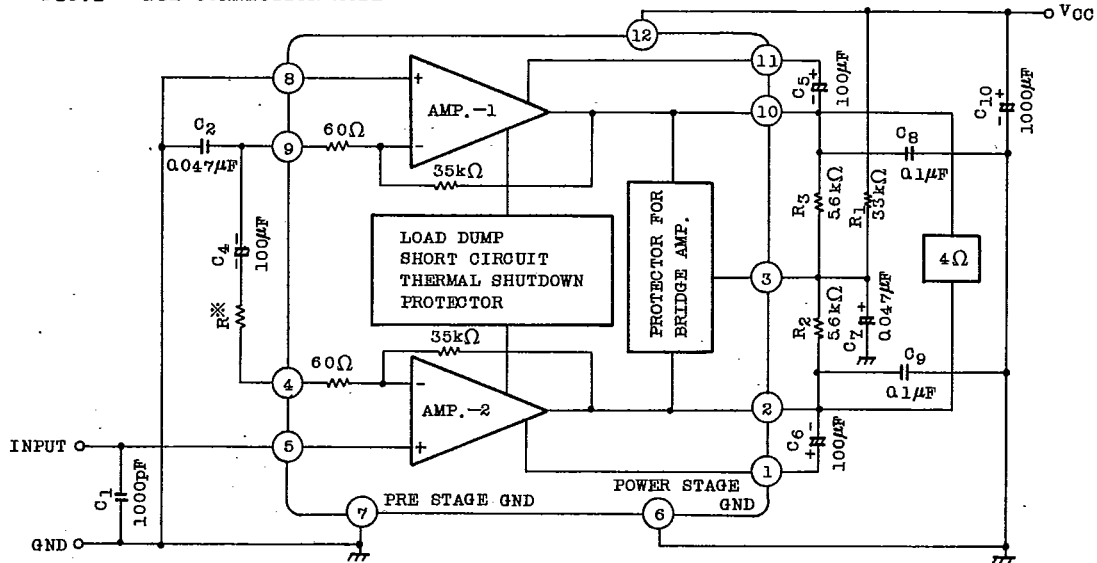

FIG.2 BTL CONNECTION MODE



Note 1. PIN 6 and PIN 7 are necessary to connect directly with GND pattern. (Care GND pattern of print board.)

2. For BTL connection, TA7227P'S normal input terminal is PIN 5, and PIN 8 is GND level.

TA7227P

T-74-05-01

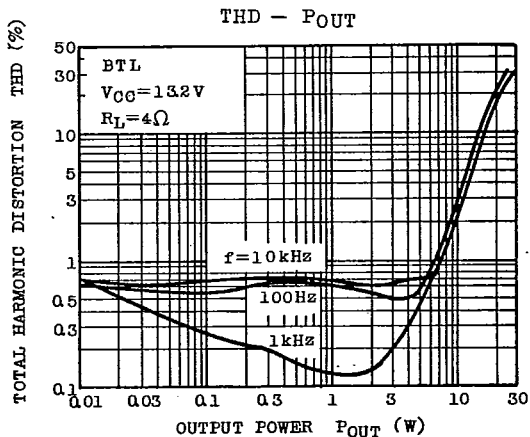
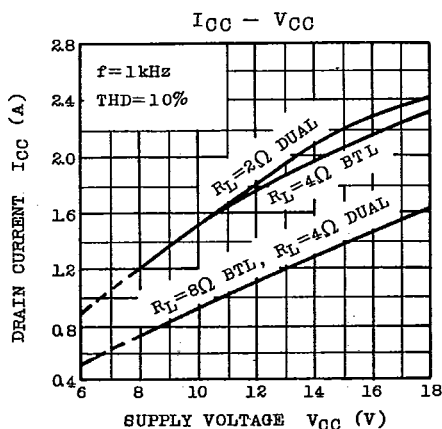
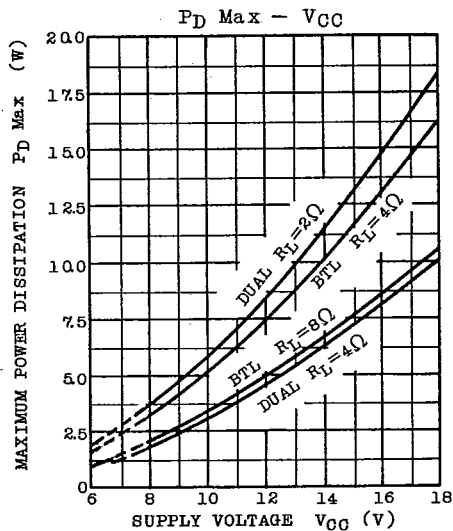
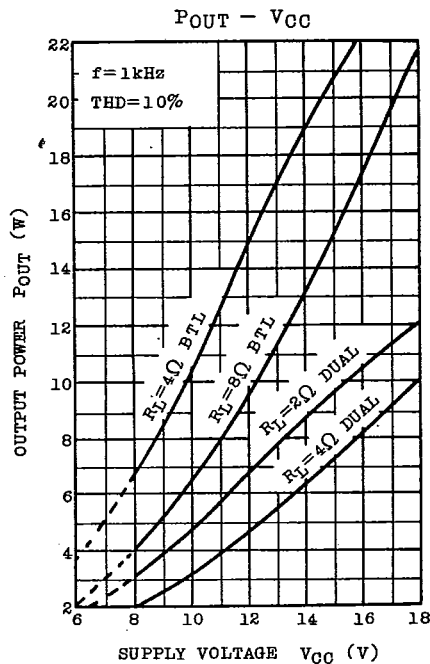
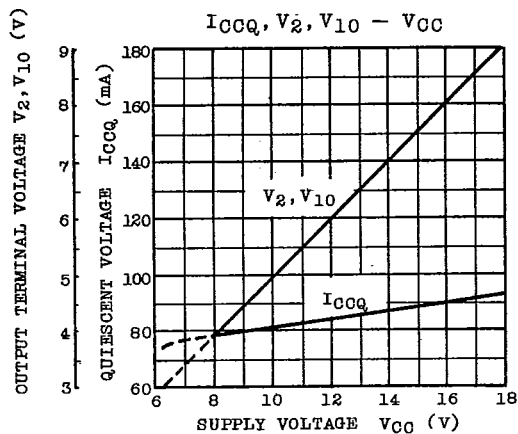

AUDIO LINEAR IC

TA7227P

T-74-05-01

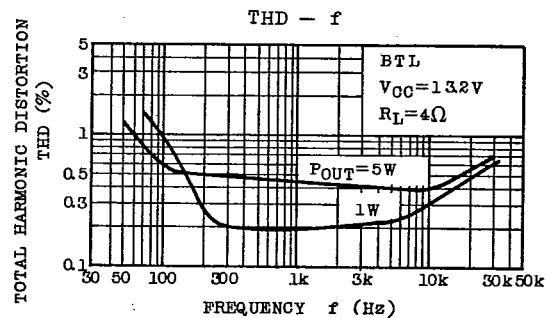
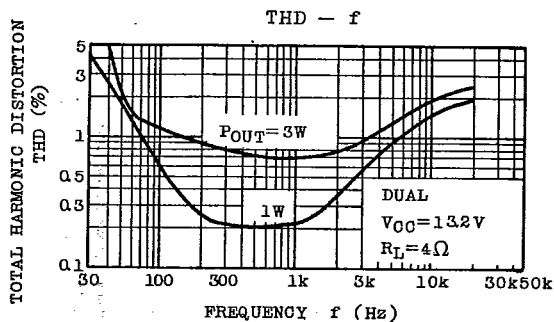
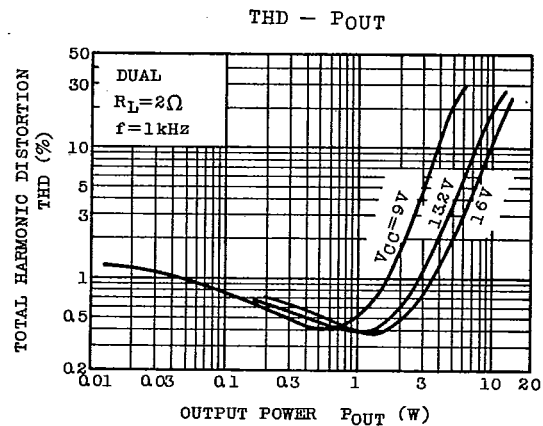
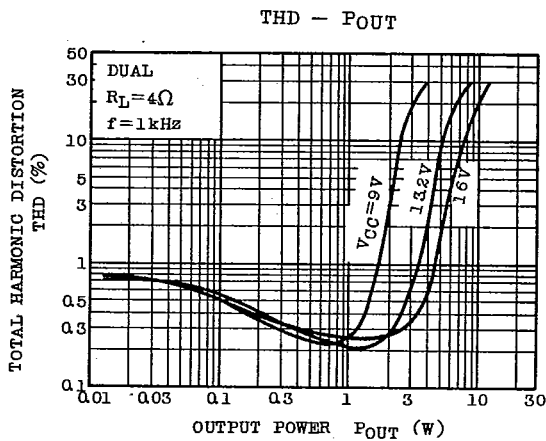
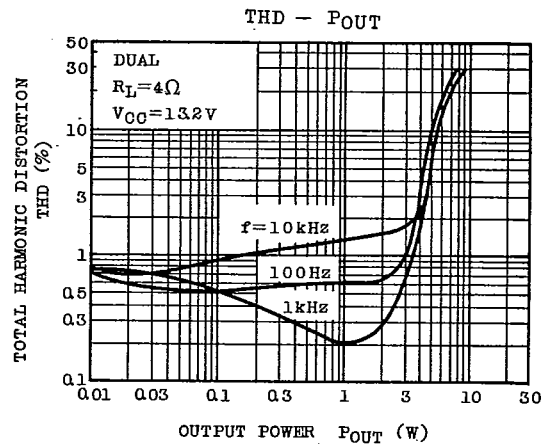
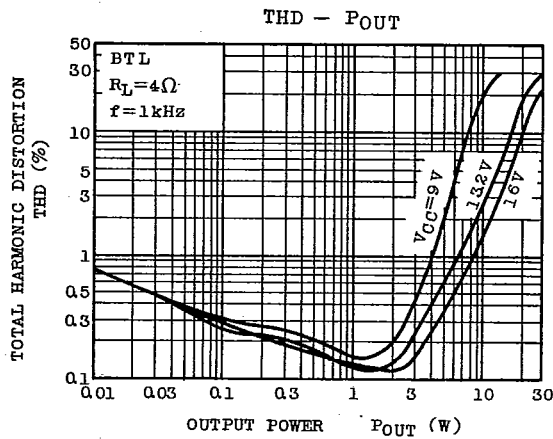

TA7227P

T-74-05-01

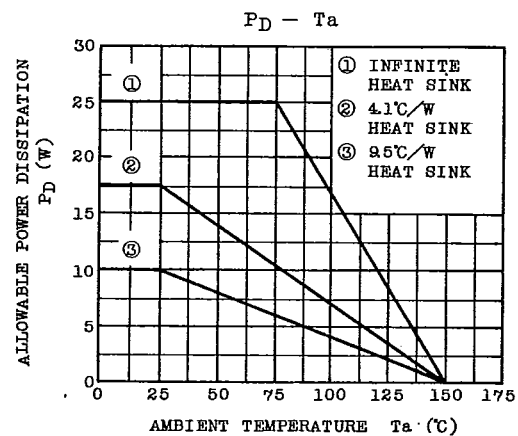
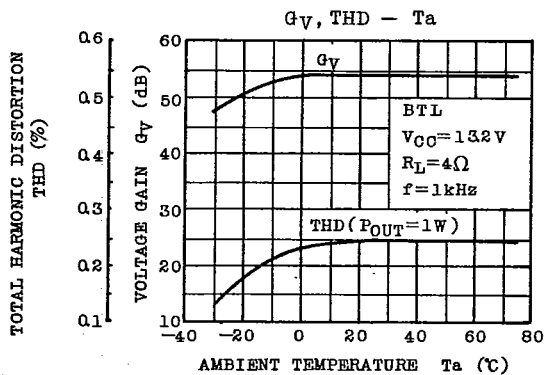
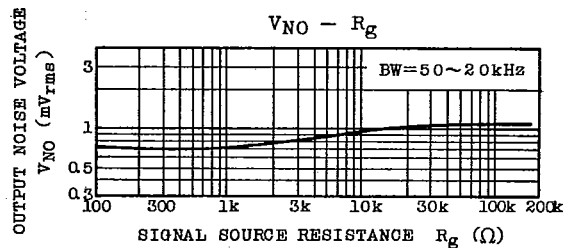
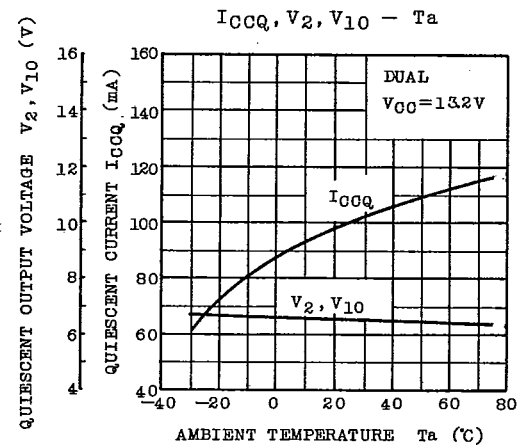
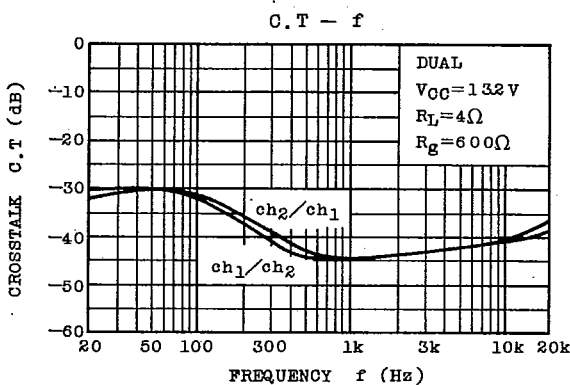
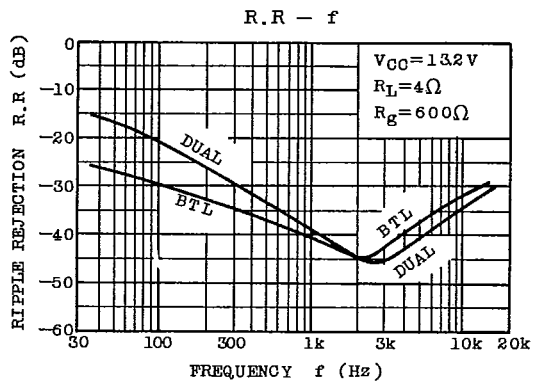
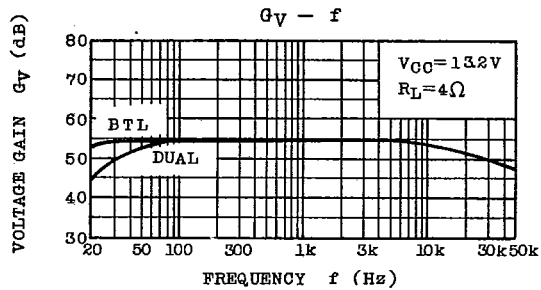

AUDIO LINEAR IC

TA7227P

T-74-05-01

PRINT BOARD (DUAL MODE)

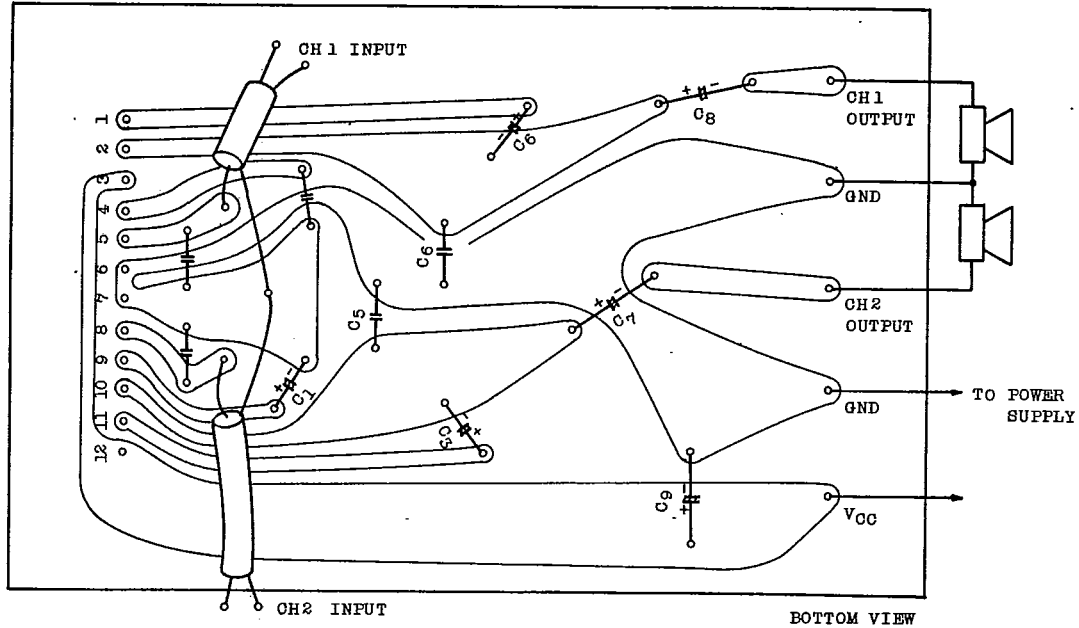

PRINT BOARD (BTL MODE)

