

CE BILGE PUMP

RETURNS

TROUBLE-SHOOTING SECTION

Symptom	possible cause	cure
Reduced Flow	Plugged strainer	Clean outside of strainer and clean debris from around impeller.
	Discharge line plugged	Clean out hose by backflushing.
	Low battery voltage	Check battery condition and charge if necessary.
	Kinked discharge hose	If hose is kinked because of sharp bend, convert to hose which will not kink at bends.
No water pumped	Wire connections	Make sure wire connections are not corroded. Visual check is not enough - a slight pull on each wire will tell if the wires are still joined. Check to be sure no wire joins are hanging down into the water.
	Fuse melted	Check fuse to see that it is the correct size if fuse still blows, check impeller through inlet opening to be sure it is not jammed or stuck with debris.
	Float switch failure	Lift end of float switch up - if pump runs, switch is OK. If pump does not run, turn Manual SWITCH TO on position - if pump runs, automatic switch has failed.

CONGRATULATIONS

You have just purchased one of the best quality bilge pumps available in the industry. It was developed after years of experience, research and testing by our research staff and thousands of users. It is built to give years reliable trouble free performance. Most early pump failures are due to improper installation and wiring. Please read and follow the instructions carefully and your pump will provide you with the maximum output and the life for which it was designed. These pumps are rated (Ignition protected)

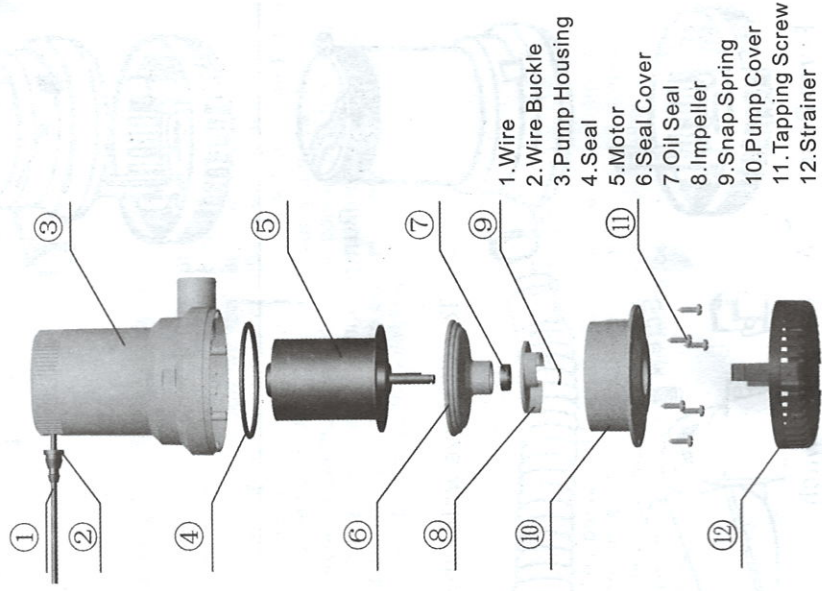

Symptom	Possible cause	Cure
Pump won't shut off	Something under float	Clean under the float to make sure debris is not holding the float up.
	Stuck float	Check to see that the float is loose and free of gummy bilge oil. If float action appears sluggish and/or the float does not move freely, intermittent or sporadic operation of the pump may occur. This condition is usually the result of oil and/or dirt accumulating in and around the movable parts of the switch. To correct, try soaking the entire switch in Marine cleaner for ten minutes, agitating several times and checking for smooth and free operation of the float. Repeat if necessary.
	Switch mounted too low	If the pump is sucking air and the automatic switch has not reached the OFF position, then the switch may be mounted too low for the pump and should be reinstalled at least 1/4 higher than the pump base.
	IMPORTANT	
Wires overheated. Melted insulation	Combination of jammed impeller and wrong size fuse.	Be sure impeller is clean of debris and is free to rotate. Reduce fuse to proper size. Replace damaged wiring and/or switch.
Repeated melted fuse	Fuse size or jammed impeller	Be sure fuse has amp rating. Check impeller to see that it is not bound up by fish line, etc.

INSTRUCTIONS

STEP 1

Remove the strainer from the bottom of the pump by depressing the lock tabs on both sides of the pump.

CAUTION: Strainer must always be properly installed before attaching and running pump.

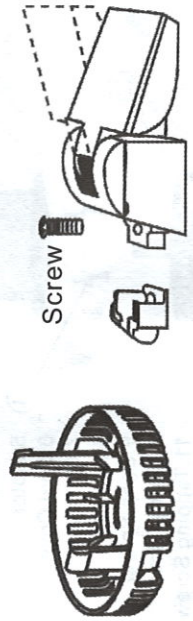
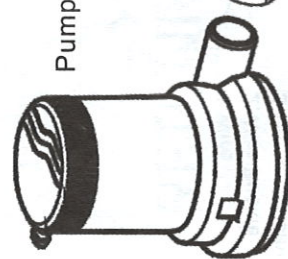
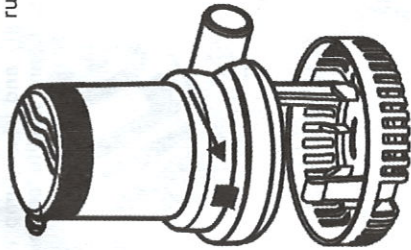

Pump Base

Adaptor

Switch

STEP 2

Determine the desired location for the pump. If only one pump is used it is usually located where the water is deepest in the bilge while the boat is at rest. The installation must allow for complete drainage of the hose. All water pockets must be eliminated by having the hose running level or continuously upward.

STEP 3

Position the strainer so that pump nozzle is in the proper position to connect to the discharge hose.

STEP 4

- A. If attaching the strainer to wood, fasten with stainless steel screws.
- B. If attaching the strainer to metal or fiberglass, first mount a wooden block and then fasten the strainer to the wooden block.

STEP 5

Mount the pump on the strainer so that both 11/2" lock-tabs snap into place. (The pump may be reversed on these tabs if so desired.)

STEP 6

Attach 1 1/8" I. D. Hose to the discharge nozzle and fasten with a stainless steel clamp. The hose (Model #80) is recommended because it will not kink when making sharp bends.

If your pump is replacing a competitive model with small diameter hose which is hard to replace, you may use the Adaptor Model #69 to adapt to the smaller hose.

Note:

Restricting the flow from the pump by using a smaller hose does not damage the pump. However, it will reduce the flow.

STEP 7 Thru-hull Fittings

A. For most installations, install a full size 11/8" I. D. Thru-hull fitting to achieve the rated flow of the pump. Located the thru-hull fitting at least 12" above the water line to prevent water from flowing back into the hull when the pump is off.

B. For stern installations, place the 11/8" thru-hull fitting high enough in the stern so that submergence of the fitting will not occur under any conditions.

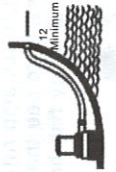

STEP 8 wiring

In order to prevent electrolysis and corroded wire connections, it's essential that all wire ends and terminals be sealed with heavy duty marine sealant and located above the highest possible water level by fastening with insulated staples or plastic straps.

When installing your pump, 16 gauge wire should be used. However, if your installation is over 20" from the battery source, the wire size should be increased to 14 gauge. Using a wire which is too small causes undesirable heat in the wires and results in a voltage drop and lower performance of the pump.

STEP 9 fusing

To protect your electrical wiring and automatic switch from possible overload install a fuse in the positive(+) lead from the battery.

If using a panel switch with a fuse holder, check to see that the proper fuse is being used. You may wish to install a panel switch with a built-in fuse holder

STEP 10

Follow one of the two wiring diagrams:

Wiring for manual Operation

The manual system is the simplest system but it only provides ON-OFF control of the pump. Consequently, pumps are often left ON longer than necessary.

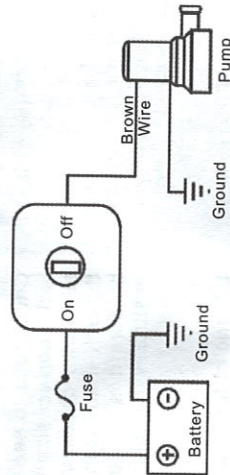

Wiring for Automatic Operation

The automatic system assures that the vessel is always pumped out, even when unattended. It extends the life of the pump and your battery by automatically shutting the pump off when the water has been pumped out.

The automatic system can also provide for manual control of the pump by installing a panel switch. These switches have a "fail-safe" feature which automatically returns the switch to the "off" position, preventing the pump from being inadvertently left on.

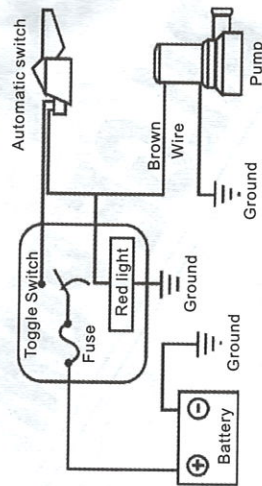

STEP 11

Polarity is important. If it is not correct, the pump rotate backwards. Water will still come out of the discharge nozzle but the flow will be very much reduced. On the 1500/2000 pump the correct polarity will be obtained when the brown wire of the pump is connected to the POS or +side of the battery. The way to verify that the direction of rotation (and thus the polarity) is correct is to look into the running and see if the impeller rotates in the direction of the arrow molded into the bottom. Never insert fingers or other objects into the inlet hole.

Storage

The pump itself is not affected by freezing temperatures. However, if the pump is embedded in ice or surrounded by ice, it cannot be used. Never turn the pump on if it is embedded in or surrounded by ice